

POWERTIP TECH. CORP.

DISPLAY DEVICES FOR BETTER ELECTRONIC DESIGN

Specification For Approval

Customer : _____

Model Type : LCD Module

Sample Code : _____

Mass Production Code : PG12864LRU-FTA-H-SA

Edit : A

Customer Sign	Sales Sign	Approved By	Prepared By

CONTENTS

1.SPECIFICATIONS

- 1.1 Features
- 1.2 Mechanical Specifications
- 1.3 Absolute Maximum Ratings
- 1.4 DC Electrical Characteristics
- 1.5 Optical Characteristics
- 1.6 Backlight Characteristics

2.MODULE STRUCTURE

- 2.1 Counter Drawing
- 2.2 Interface Pin Description
- 2.3 Timing Characteristics
- 2.4 Display command
- 2.5 Character Pattern



POWERTIP TECHNOLOGY CORPORATION

DISPLAY DEVICES FOR BETTER ELECTRONIC DESIGN

1. SPECIFICATIONS

1.1 Features

- Full dot-matrix structure with 128 dots *64 dots
- 1/64 Duty, 1/9 bias
- STN LCD, positive, yellow green
- Transflective LCD
- 6 o'clock viewing angle
- 8 bits parallel data input ,with controller IC T6963C, QFP type
- LED backlight

1.2 Mechanical Specifications

- Outline dimension : 78.0mm(L) *70.0mm(W)*13.8mm max.(H)
- Viewing area : 62.0mm *44.0mm
- Active area : 56.27mm *38.35mm
- Dot size : 0.39mm *0.55mm
- Dot pitch : 0.44mm *0.6mm

1.3 Absolute Maximum Ratings

Item	Symbol	Conditions	Min.	Max.	Unit
Power supply Voltage	VDD	-	0	7.0	V
LCD drive Supply voltage	VDD-VEE	-	-	19.0	V
Input voltage	VIN	-	-0.3	VDD+0.3	V
Operating temperature	TOPR	-	-20	70	°C
Storage temperature	TSTG	-	-30	80	°C
Humidity*1	HD	-	-	90	%RH

1.4 DC Electrical Characteristics

VDD=+5V±10%,VSS=0V,TA=25°C

Item	Symbol	Condition	Min.	Typ.	Max.	Unit
Logic Supply voltage	VDD	-	4.5	5	5.5	V
“H” input voltage	VIH	-	0.8VDD	-	VDD	V
“L” input voltage	VIL	-	0	-	0.2VDD	V
“H” output voltage	VOH	-	VDD-0.3	-	-	V
“L” output voltage	VOL	-	-	-	0.3	V
Supply current	IDD	VDD=5V	9.4	10	10.4	mA
LCD driving voltage	VOP	VDD-VO	8.5	9.1	10.5	V



POWERTIP TECHNOLOGY CORPORATION

DISPLAY DEVICES FOR BETTER ELECTRONIC DESIGN

1.5 Optical Characteristics

1/64 duty, 1/9 bias, $V_{opr}=9.1V$, $T_a=25^{\circ}C$

Item	Symbol	Conditions	Min.	Typ.	Max	Reference
Viewing angle	θ	$C \geq 2.0, \varnothing = 0^{\circ}C$	30°	-	-	Notes 1 & 2
Contrast	C	$\theta = 5^{\circ}, \varnothing = 0^{\circ}$	2	3	-	Note 3
Response time(rise)	t_r	$\theta = 5^{\circ}, \varnothing = 0^{\circ}$	-	300ms	500ms	Note 4
Response time(fall)	t_f	$\theta = 5^{\circ}, \varnothing = 0^{\circ}$	-	500ms	800ms	Note 4

Note 1: Definition of angles θ and \varnothing

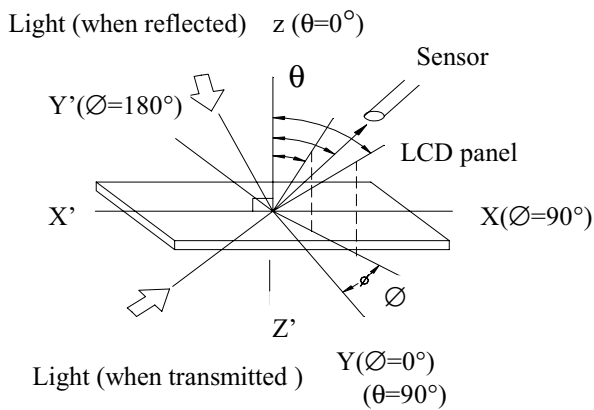

Note 2: Definition of viewing angles θ_1 and θ_2

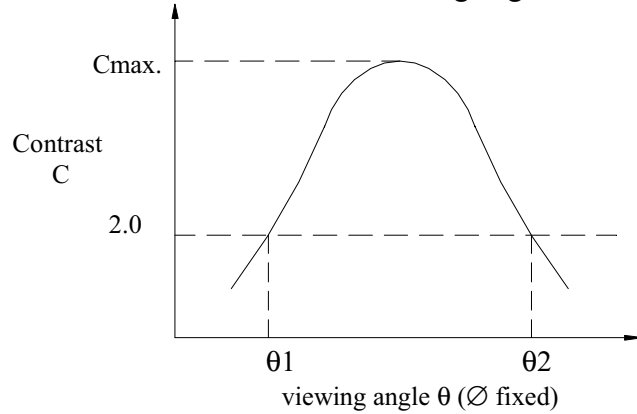

Note : Optimum viewing angle with the naked eye and viewing angle θ at C_{max} . Above are not always the same

Note 3: Definition of contrast C

$$C = \frac{\text{Brightness (reflection) of unselected dot (B2)}}{\text{Brightness (reflection) of selected dot (B1)}}$$

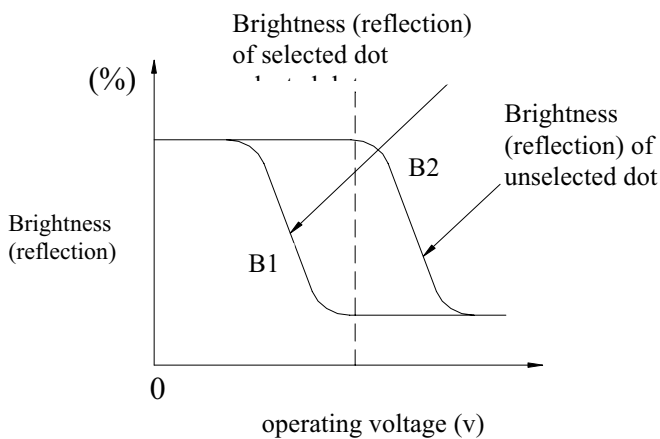

Note 4: Definition of response time

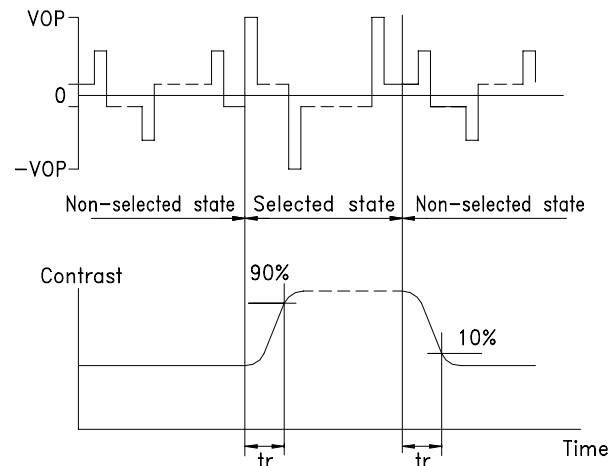

Note: Measured with a transmissive LCD panel which is displayed 1 cm^2

V_{opr} : Operating voltage f_{FRM} : Frame frequency
 t_r : Response time (rise) t_f : Response time (fall)



POWERTIP TECHNOLOGY CORPORATION
 DISPLAY DEVICES FOR BETTER ELECTRONIC DESIGN

1.6 Backlight Characteristic Backlight Characteristic

The LCD Module is backlight using a LED panel

•.Maximum Ratings

Item	Symbol	Conditions	Min.	Max.	Unit
Forward current	IF	TA=25°C	-	850	mA
Reverse voltage	VR	TA=25°C	-	8	V
Power dissipation	PO	TA=25°C	-	4.02	W
Operating Temperature	TOPR	-	-20	70	°C
Storage temperature	TSTG	-	-40	80	°C

•.Electrical Ratings

Item	Symbol	Condition	Min.	Typ.	Max.	Unit
Forward voltage	VF	25°C	3.8	4.2	4.6	V
Reverse current	IR	25°C	-	8	8	mA
Luminous intensity	IV	IF=350mA	16	270	20	cd/m ²
Wavelength	HUE	IF=350mA	571	576	576	nm
Color	Yellow Green					



POWERTIP TECHNOLOGY CORPORATION

DISPLAY DEVICES FOR BETTER ELECTRONIC DESIGN

2. MODULE STRUCTURE

2.1 Counter Drawing

*See Appendix

2.2 Interface Pin Description

Pin No.	Symbol	Function
1	FG	Frame ground (connected to metal bezel)
2	VSS	Signal ground (GND)
3	Vdd	Power supply for logic (+5V)
4	V0	Power supply for lcd drive (should be variable)
5	$\overline{\text{WR}}$	Data write (write data to the module at "L")
6	$\overline{\text{RD}}$	Data read (read data from the module at "L")
7	$\overline{\text{CE}}$	Chip enable for the module (active at "L")
8	$\text{C}/\overline{\text{D}}$	$\text{C}/\overline{\text{D}} = \text{"H"}$: read or write command $\text{C}/\overline{\text{D}} = \text{"L"}$:read or write data.
9	$\overline{\text{RESET}}$	Controller reset (module reset)
10~17	D0~D7	Data bus (D0=MSB, D7=LSB)
18	FS	Font select :open or connect to Vdd : 6*8 Dots font connect to Vss : 8*8 Dots font
19	K	Power supply for LED B/L "Ground"
20	A	Power supply for LED B/L "+"

Contrast Adjust

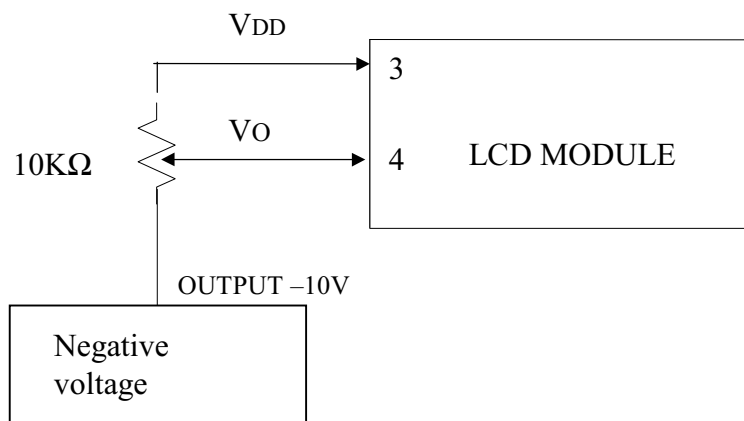

POWERTIP TECHNOLOGY CORPORATION

DISPLAY DEVICES FOR BETTER ELECTRONIC DESIGN

2.3 Timing Characteristics

Bus Timing

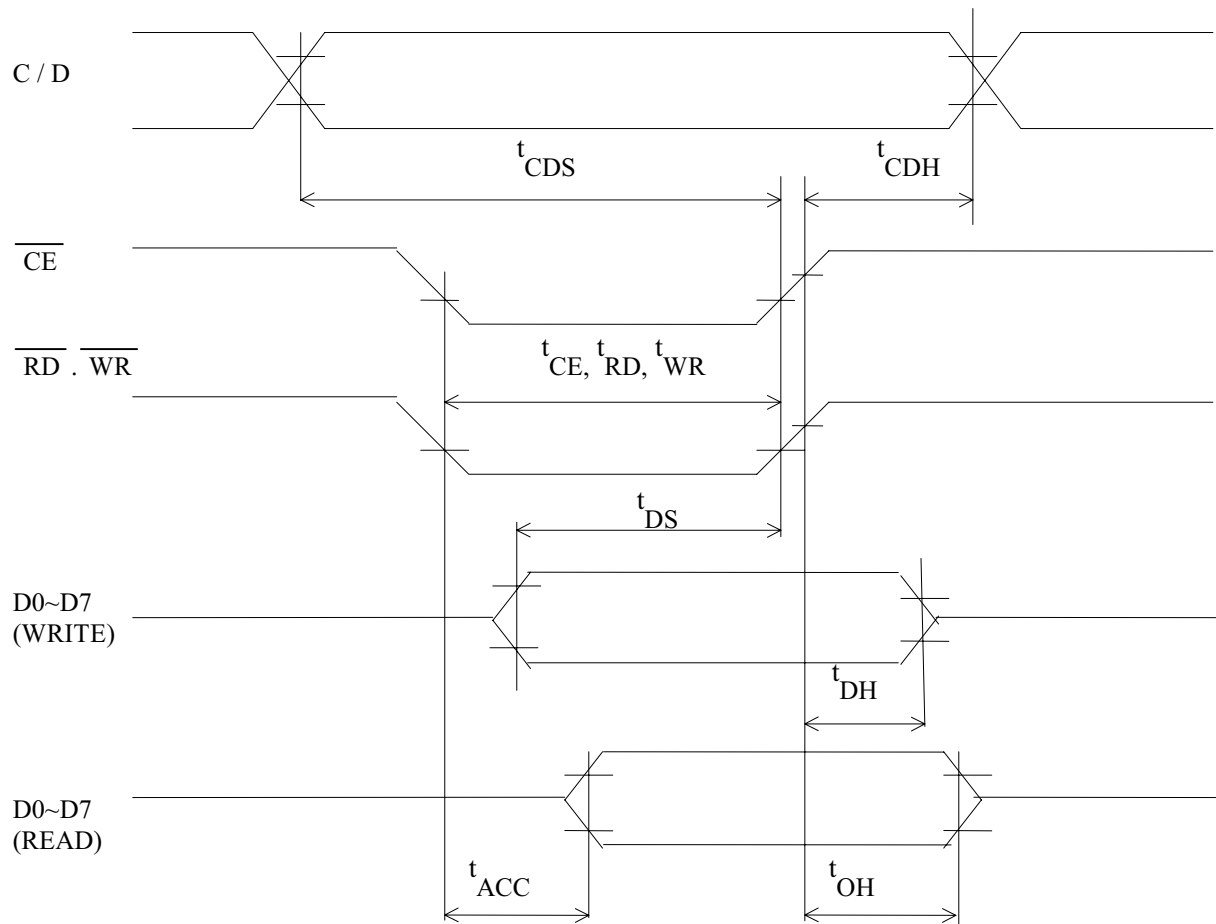

POWERTIP TECHNOLOGY CORPORATION

DISPLAY DEVICES FOR BETTER ELECTRONIC DESIGN

Read cycle

VDD=+5V±10%,VSS=0V,TA=25°C

Item	Symbol	Condition s	Min.	Max	Unit
C/D Set up time	tCDS	-	100	-	ns
C/D Hold time	tCDH	-	10	-	ns
$\overline{\text{CE}}$, $\overline{\text{RD}}$, $\overline{\text{WR}}$ Pulse width	tCE,tRD,tWR	-	80	-	ns
Access time	tACC	-	-	150	ns
Output hold time	tOH	-	10	50	ns

Write cycle

Item	Symbol	Condition s	Min.	Max	Unit
C/D Set up time	tCDS	-	100	-	ns
C/D Hold time	tCDH	-	10	-	ns
$\overline{\text{CE}}$, $\overline{\text{RD}}$, $\overline{\text{WR}}$ Pulse width	tCE,tRD,tWR	-	80	-	ns
Data set up time	tDS	-	80	-	ns
Data hold time	tDH	-	40	-	ns

*POWERTIP TECHNOLOGY CORPORATION*

DISPLAY DEVICES FOR BETTER ELECTRONIC DESIGN

2.4 Display command

1.Register Set

Code	Hex.	Function	D1	D2
00100001	21H	Cursor pointer set	X ADRS	Y ADRS
00100010	22H	Offset register set	Data	00H
00100100	24H	Address pointer set	Low ADRS	High ADRS

(1) Cursor pointer set

The position of cursor is specified by X ADRS, Y ADRS. The cursor position is moved only by this command. The cursor pointer doesn't have the function of increment and decrement. The shift of cursor are set by this command. X ADRS, Y ADRS are specified following.

X ADRS 00H~4FH (Lower 7bits are valid)

Y ADRS 00H~1FH (Lower 5 bits are valid)

1. 1 screen drive

X ADRS 00~4FH

Y ADRS 00H~0FH

2. 2 screens drive

X ADRS 00~4FH

Y ADRS 00H~0FH

Upper screen

Y ADRS 10H~1FH

Lower screen

(2) Offset register set

The offset register is used to determine external character generator RAM area.

T693C has 16 bit address lines as follow.

MSB														LSB	
ad15	ad14	ad13	ad12	ad11	ad10	ad9	ad8	ad7	ad6	ad5	ad4	ad3	ad2	ad1	ad0

The upper 5 bit (ad15~ad11) are determined by offset register. The middle 8 bit (ad10~ad3) are determined by character code. The lower 3 bit (ad2~ad0) are determined by vertical counter. The lower 5 bit of D1 (data) are valid.

The data format of external character generator RAM.



POWERTIP TECHNOLOGY CORPORATION

DISPLAY DEVICES FOR BETTER ELECTRONIC DESIGN

The relationship of display RAM address and offset register

Data of offset register	CG RAM HEX. Address (start-end)
00000	0000-07FFH
00001	0800-0FFFH
00010	1000-17FFH
11100	E000-E7FFH
11101	E800-EFFFH
11110	F000-F7FFH
11111	F800-FFFFH

(Example 1)

Offset register	02H
Character code	80H
Character generator RAM start address	0001 0100 0000 0000 1 4 0 0 H

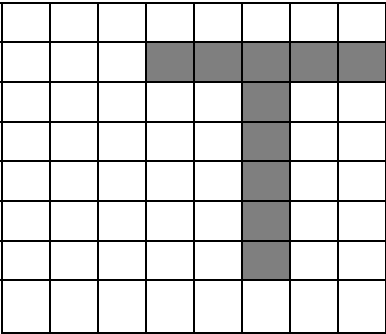
	(Address)	(Data)
	1400H	00H
	1401H	1FH
	1402H	04H
	1403H	04H
	1404H	04H
	1405H	04H
	1406H	04H
	1407H	00H

(Example 2) The relationship of display RAM data and display character

	(RAM DATA)	(Character)
	21H	A
	22H	B
	83H	γ
	24H	D
	25H	E
	86H	ζ

Display character

γ and ζ are displayed by character generator RAM.

(3)Address pointer set

The address pointer set command is used to indicate the start address for writing (or reading) to external RAM.

The flow chart address pointer set command

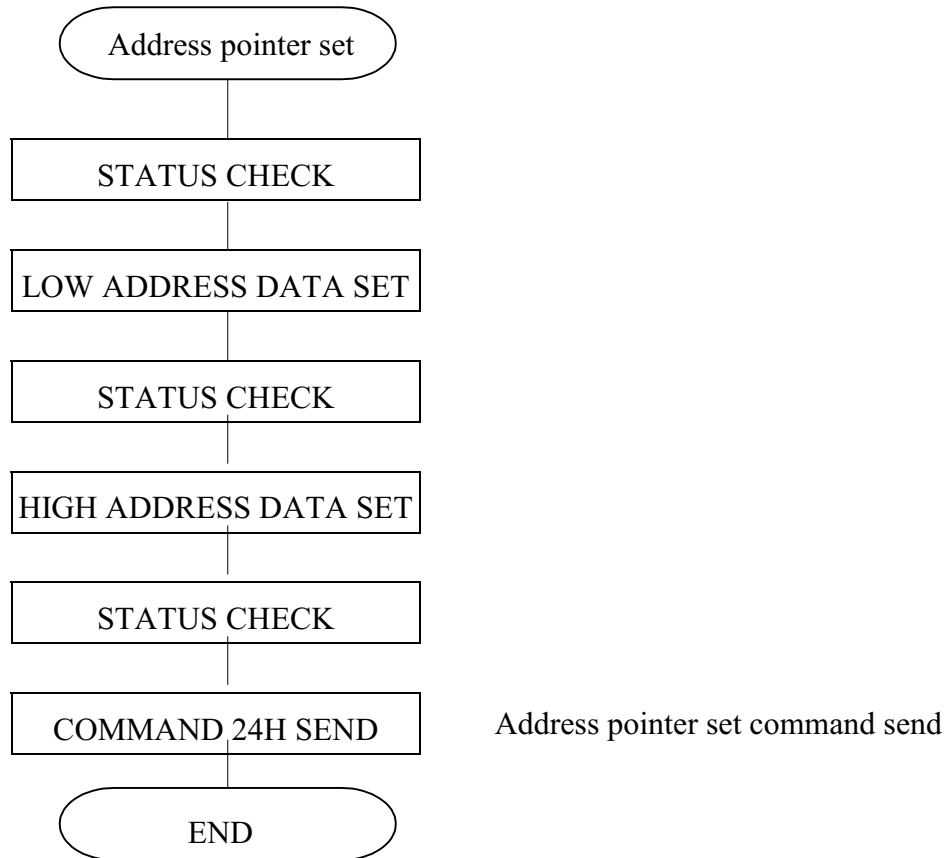

2.Control word set

Code	Hex.	Function	D1	D2
01000000	40H	Text home address set	Low address	High address
01000001	41H	Text area set	Columns	00H
01000010	42H	Graphic home address set	Low address	High address
01000011	43H	Graphic area set	Columns	00H

The home address and column size are defined by this command.



POWERTIP TECHNOLOGY CORPORATION

DISPLAY DEVICES FOR BETTER ELECTRONIC DESIGN

(1)Text home address set

The starting address of external display RAM for Text display is defined by this command. The text home address shows the left end and most upper position.

The relationship of external display RAM address and display position

TH		TH+CL
TH+TA		TH+TA+CL
(TH+TA)+TA		TH+2TA+CL
(TH+2TA)+TA		TH=3TA+CL
TH+(n-1)TA		TH+(n-1)TA+CL

TH : Text home address

TA : Text area number (columns)

CL : Columns are fixed by hardware. (pin-programmable)

(Example)

Text home address : 0000H
 Text area : 0020H
 MD2=H, MD3=H : 32 columns
 DUAL=H, MDX=L, MD1=H : 4 lines

0000H	0001H		001EH	001FH
0020H	0021H		003EH	003FH
0040H	0041H		005EH	005FH
0060H	0061H		007EH	007FH

(2)Graphic home address set

The starting address of external display RAM for Graphic display is defined by this command. The Graphic home address show the left end most upper line.

The relationship of external display RAM address and display position

GH		GH+CL
GH+GA		GH+GA+CL
(GH+GA)+GA		GH+2GA+CL
(GH+2GA)+GA		GH=3GA+CL
GH+(n-1)GA		GH+(n-1)GA+CL

GH : Graphic home address

GA : Graphic area number (columns)

CL : Columns area fixed by hardware. (pin-programmable)



POWERTIP TECHNOLOGY CORPORATION

DISPLAY DEVICES FOR BETTER ELECTRONIC DESIGN

(Example)

Graphic home address : 0000H
 Graphic area : 0020H
 MD2=H, MD3=H : 32 columns
 DUAL =H, MDS=L, MD0=H, MD1=H : 2 lines

0000H	0001H		001EH	001FH
0020H	0021H		003EH	003FH
0040H	0041H		005EH	005FH
0060H	0061H		007EH	007FH
0080H	0081H		009EH	009FH
00A0H	00A1H		00BEH	00BFH
00C0H	00C1H		00DEH	00DFH
00E0H	00E1H		00FEH	00FFH
0100H	0101H		011EH	011FH
0120H	0121H		013EH	013FH
0140H	0141H		015EH	015FH
0160H	0161H		017EH	017FH
0180H	0181H		019EH	019FH
01A0H	01A1H		01BEH	01BFH
01C0H	01C1H		01DEH	01DFH
01E0H	01E1H		01FEH	01FFH

(3)Text area set

The columns of display are defined by the hardware setting. This command can be used to adjust columns of display.

(Example)

LCD size : 20 columns, 4 lines
 Text home address : 0000H
 Text area : 0014H
 MD2=H, MD3=H : 32 columns
 DUAL=H, MDS=L, MD0=L, MD1=H : 4 lines

0000	0001	0013	0014	001F
0014	0015	0027	0028	0033
0028	0029	003B	003C	0047
003C	003D	004F	0050	005B

LCD



POWERTIP TECHNOLOGY CORPORATION

DISPLAY DEVICES FOR BETTER ELECTRONIC DESIGN

(4)Graphic area set

The columns of display are defined by the hardware setting. This command can be used to adjust columns of graphic display.

(Example)

LCD size : 20 columns, 2 lines
 Text home address : 0000H
 Text area : 0014H
 MD2=H, MD3=H : 32 columns
 DUAL=H, MDS=L, MDD=H, MD1=H : 2 lines

0000	0001	0013	0014	001F
0014	0015	0027	0028	0033
0028	0029	003B	003C	0047
003C	003D	004F	0050	005B
0050	0051	0063	0064	006F
0064	0065	0077	0078	0083
0078	0079	008B	008C	0097
008C	008D	009F	00A0	00AB
00A0	00A1	00B3	00B4	00BF
00B4	00B5	00C7	00C8	00D3
00C8	00C9	00DB	00DC	00E7
00DC	00DD	00EF	00F0	00FD
00F0	00F1	0103	0104	011F
0104	0105	0127	0128	0123
0128	0129	013B	013C	0147
013C	013D	014F	0150	0158



The address in graphic area can be continuous and RAM area can be used without ineffective area, if graphic area is defined the same number as the actual column number of LCD display.

3.Mode set

Code	Function	Operand
1000x000	“OR” Mode	-
1000x001	“EXOR” Mode	-
1000x011	“AND” Mode	-
1000x100	“TEXT ATTRIBUTE” Mode	-
10000xxx	Internal Character Generator Mode	-
10001xxx	External Character Generator Mode	-

The display mode is defined by this command. The display mode don't have changed until to send next this command. Logically “OR”, “EXOR”, “AND” of text and graphic display can be displayed. When internal character generator mode is selected, character code 00H~7FH are selected from built-in character generator ROM. The character code 80H~FFH are automatically selected external character generator RAM.

(Example)

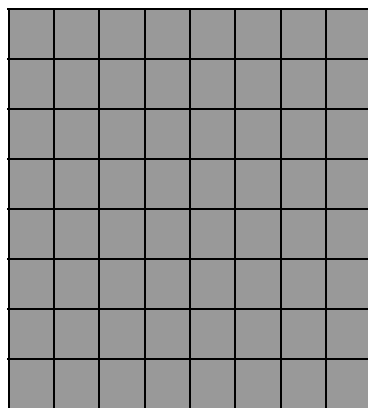

Graphic

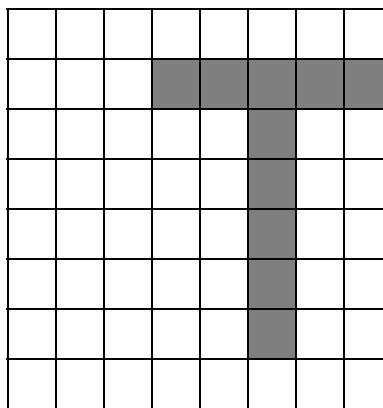

Text

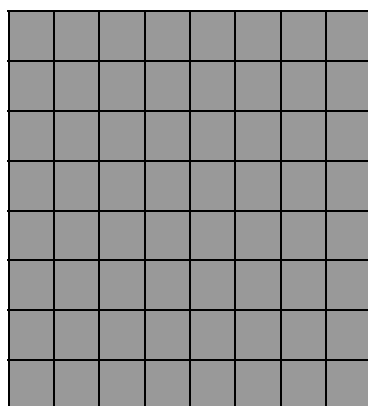

“OR”

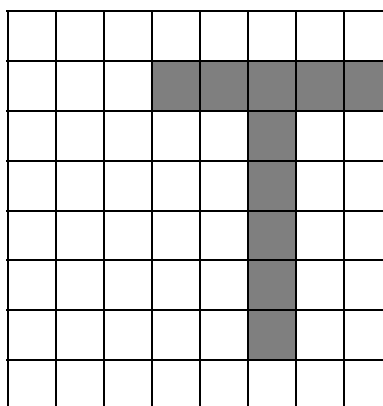

“AND”

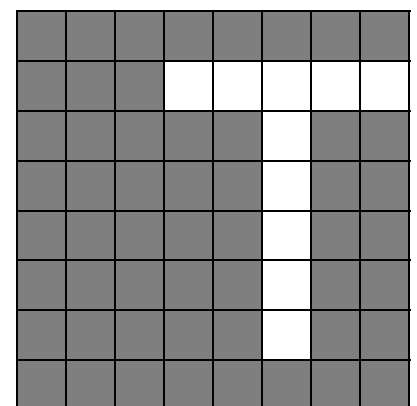

“EXOR”

Note: Only text display is attributed, because attribute data is located in graphic RAM area.



POWERTIP TECHNOLOGY CORPORATION

DISPLAY DEVICES FOR BETTER ELECTRONIC DESIGN

Attribute function

“Reverse display”, “Character blink” and “Inhibit” are called “Attribute”. The attribute data is written in the graphic area defined by Control word set command.

The mode set command selects text display only and graphic display cannot be displayed.

The attribute data of the 1st character in text area is written at the 1st 1byte in graphic area, and attribute data of n-th character is written at the n-th 1byte in graphic area. Attribute function is defined as follow.

Attribute RAM 1byte

X	X	X	X	d3	d2	d1	d0
---	---	---	---	----	----	----	----

d3	d2	d1	d0	Function
0	0	0	0	Normal display
0	1	0	1	Reverse display
0	0	1	1	Inhibit display
1	0	0	0	Blink of normal display
1	1	0	1	Blink of reverse display
1	0	1	1	Blink of inhibit display

X : Don't care

4.Display mode

Code	Function	Operand
10010000	Display off	-
1001xx10	Cursor on , blink off	-
1001xx11	Cursor on , blink on	-
100101xx	Text on, graphic off	-
100110xx	Text off, graphic on	-
100111xx	Text on , graphic on	-

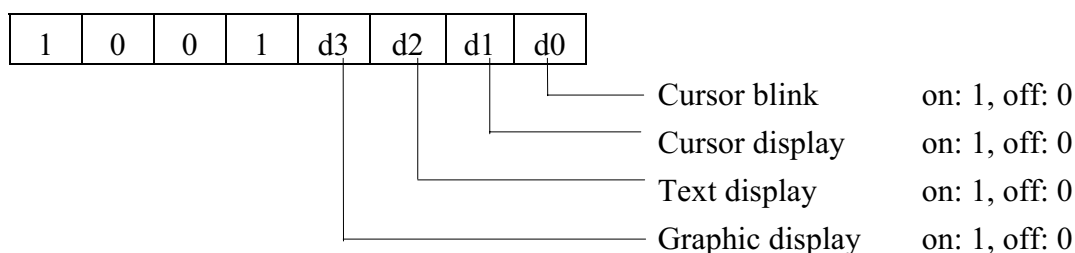

Note: It is necessary to turn on “Text display” and “ Graphic display “ in following case.

- (1) Combination of text/graphic display
- (2) Attribute function



POWERTIP TECHNOLOGY CORPORATION

DISPLAY DEVICES FOR BETTER ELECTRONIC DESIGN

5. Cursor pattern select

Code	Function	Operand
10100000	1 line cursor	-
10100001	2 lines cursor	-
10100010	3 lines cursor	-
10100011	4 lines cursor	-
10100100	5 lines cursor	-
10100101	6 lines cursor	-
10100110	7 lines cursor	-
10100111	8 lines cursor	-

When cursor display is ON, this command selects the cursor pattern from 1 line to 8 lines. The cursor address is defined by cursor pointer set command.

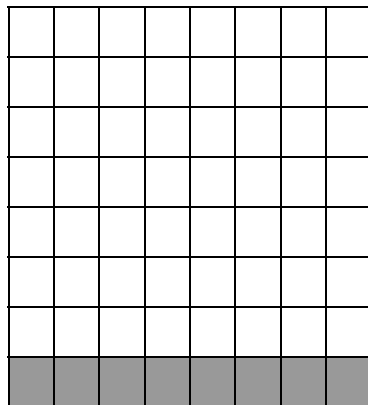

1 line cursor

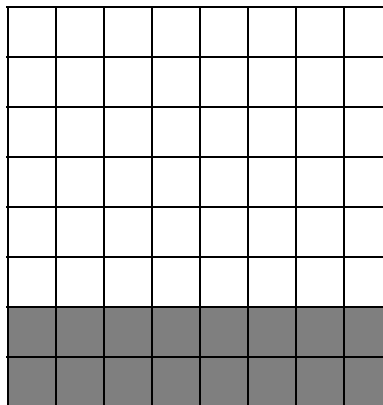

2 lines cursor

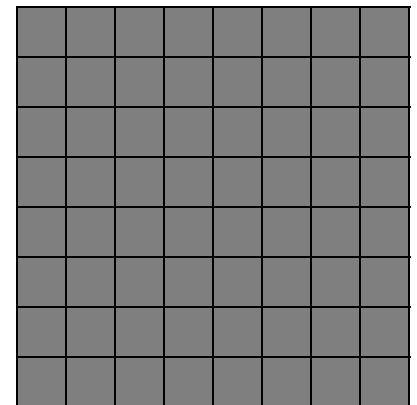

8 lines cursor

6. Data auto read/write

Code	Hex.	Function	Operand
10110000	B0H	Data auto write set	-
10110001	B1H	Data auto read set	-
10110010	B2H	Auto reset	-

This command is convenient to send full screen data from external display RAM.

After setting auto mode, “Data write (or read)” command is not necessary between each data. “Data write (or read)” command should follow the “Address pointer set” and address pointer is automatically increment by + 1 after each data. After sending (or receiving) all data “Auto reset” is necessary to return normal operation because all data is regarded “Display data” and no command can be accepted in the auto mode.



POWERTIP TECHNOLOGY CORPORATION

DISPLAY DEVICES FOR BETTER ELECTRONIC DESIGN

Note : Status check for auto mode (STA2, STA should be checked between each data.
 Auto reset should be performed after checking STA3=1 (STA2=1).
 Please refer following flow chart.

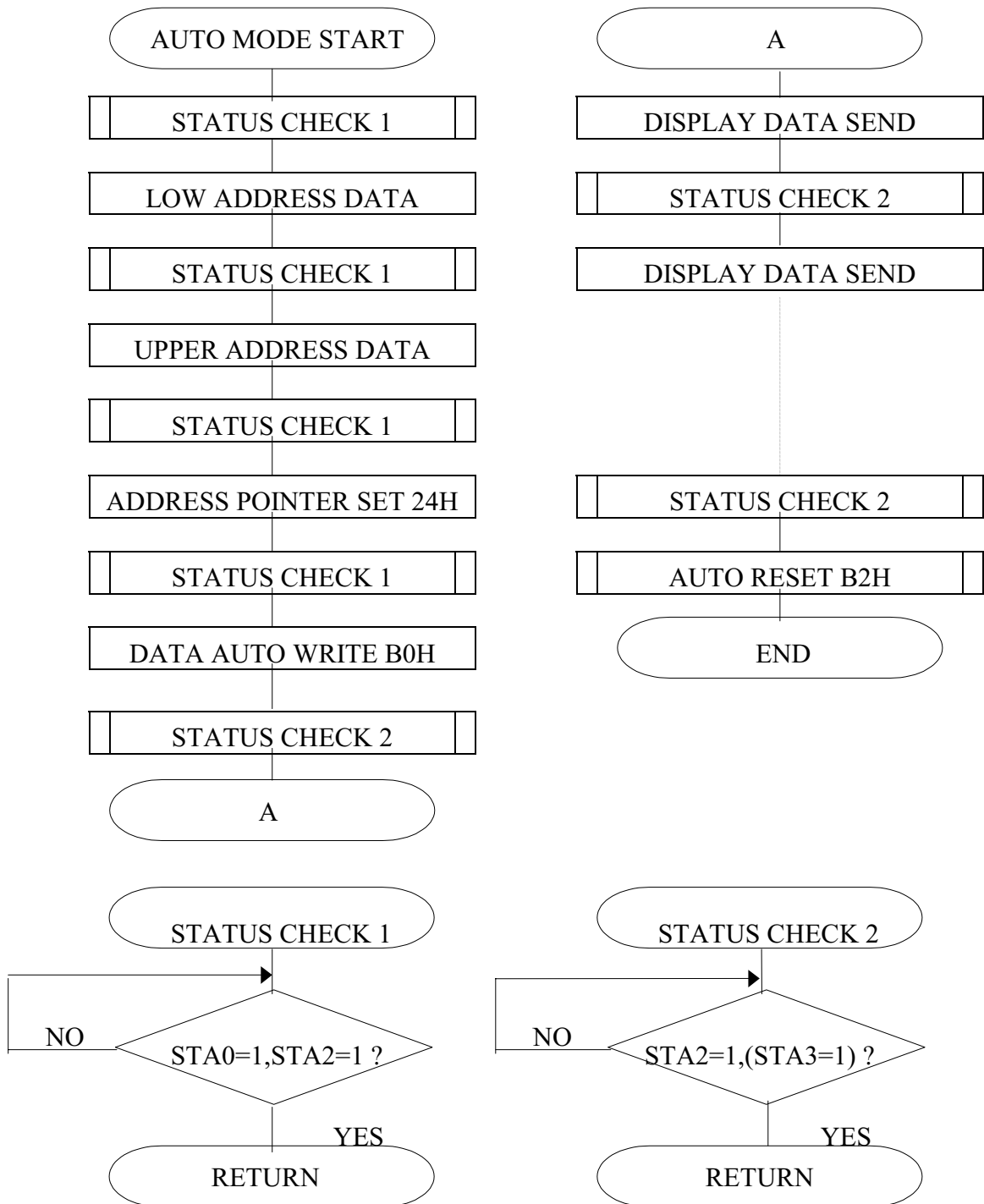

7.Data read write

Code	Hex.	Function	Operand
11000000	C0H	Data write and ADP increment	Data
11000001	C1H	Data read and ADP increment	-
11000010	C2H	Data write and ADP decrement	Data
11000011	C3H	Data read and ADP decrement	-
11000100	C4H	Data write and ADP nonvariable	Data
11000101	C5H	Data read and ADP nonvariable	-

This command is used for data write from MPU to external display RAM, and data read from external display RAM to MPU. Data write/data read should be executed after setting address by address pointer set command. Address pointer can be automatically increment or decrement by setting this command.

Note: This command is necessary for each 1 byte data.

Please refer following flow chart.

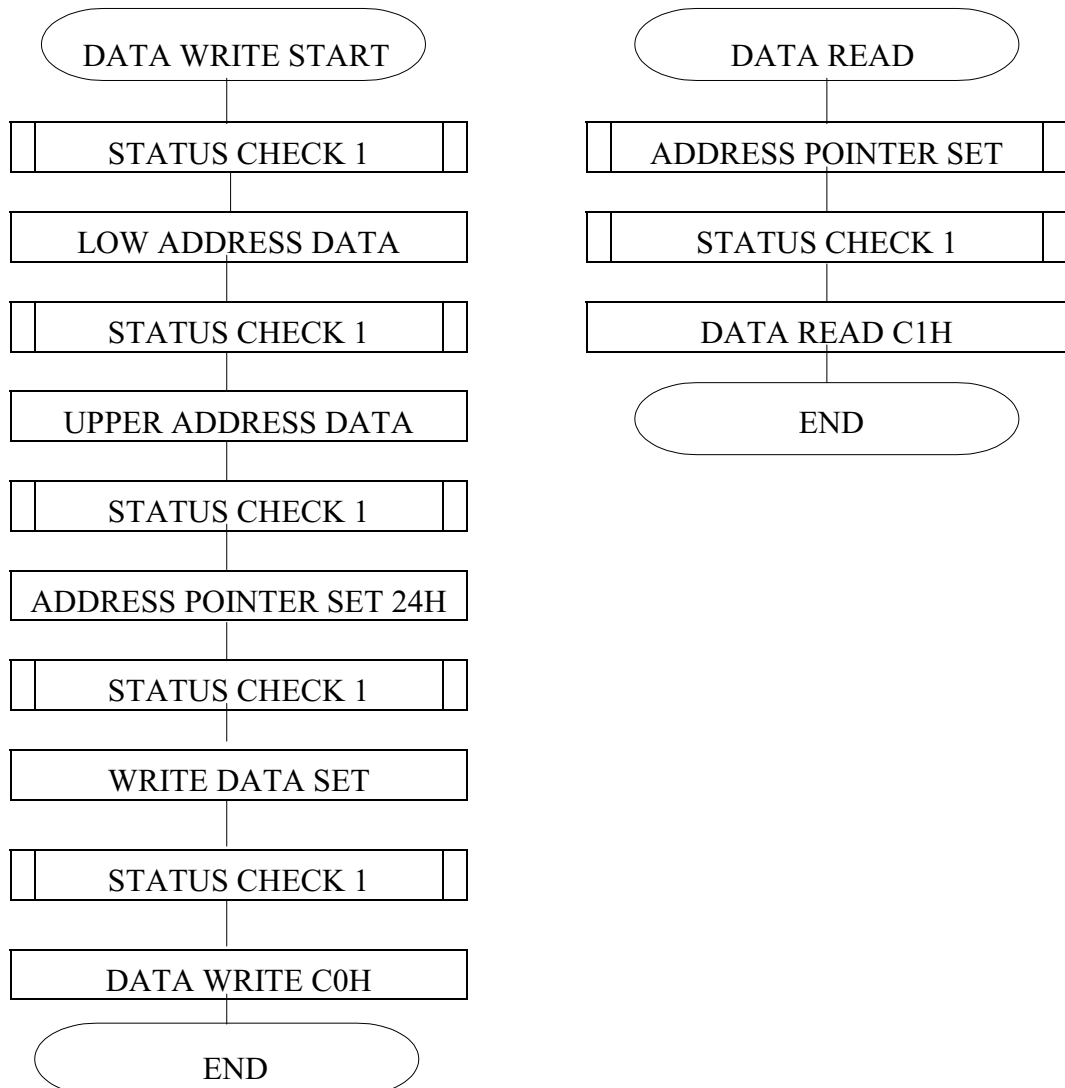

POWERTIP TECHNOLOGY CORPORATION

DISPLAY DEVICES FOR BETTER ELECTRONIC DESIGN

8.Screen peek

Code	Hex.	Function	Operand
11100000	E0H	screen peek	-

This command is used to transfer displayed 1 byte data to data stack, and this 1 byte data can be read from MPU by data access. The logical combination data of text and graphic display on LCD screen can be read by this command.

The status (STA6) should be checked just after “Screen peek” command. If the address determined by “Address pointer set” command is not in graphic area, this command ignored and status flag (STA6) is set.

Please refer following flow chart.

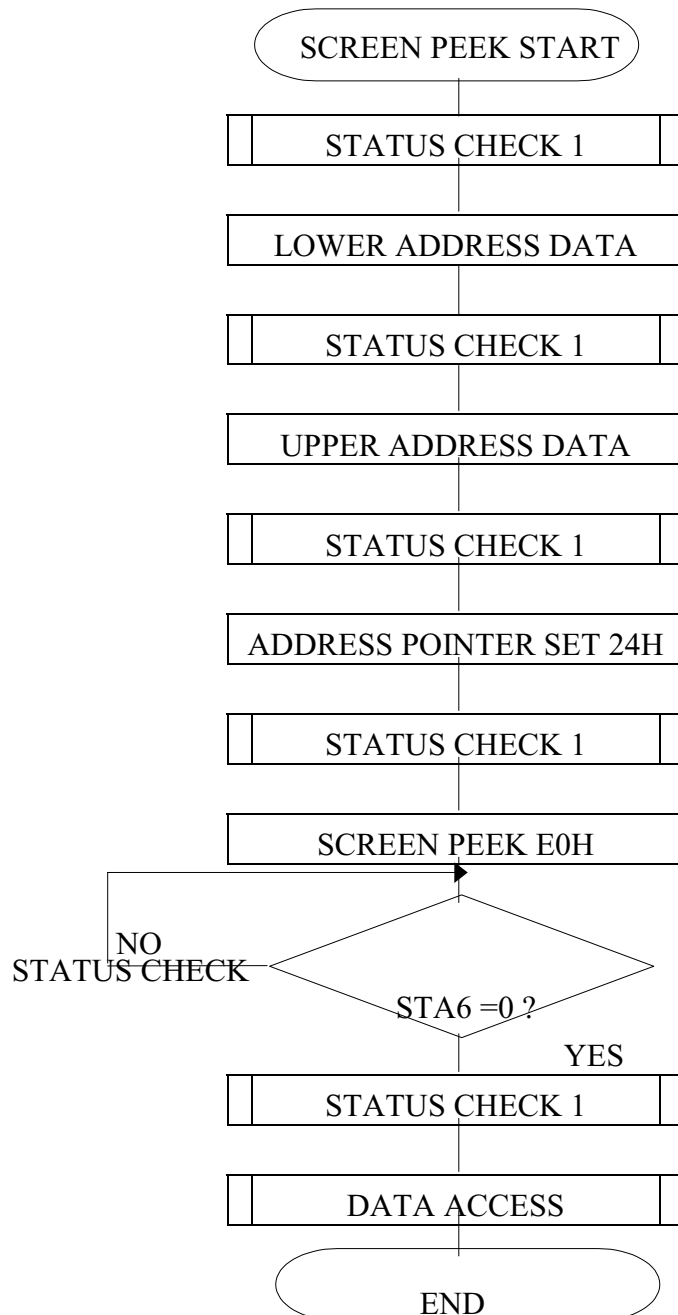

POWERTIP TECHNOLOGY CORPORATION

DISPLAY DEVICES FOR BETTER ELECTRONIC DESIGN

9.Screen copy

Code	Hex.	Function	Operand
11101000	E8H	screen copy	-

This command is used to copy displayed 1 line data to graphic area. The start point of 1 line data in the screen is determined by the address pointer.

Note: (1) In attribute function, this command is invalid.

(Because attribute data is in the graphic area.)

(2) In case of 2 screen drive, this command is invalid. (Because T693C cannot separate upper screen data and lower screen data.)

Please refer following flow chart.

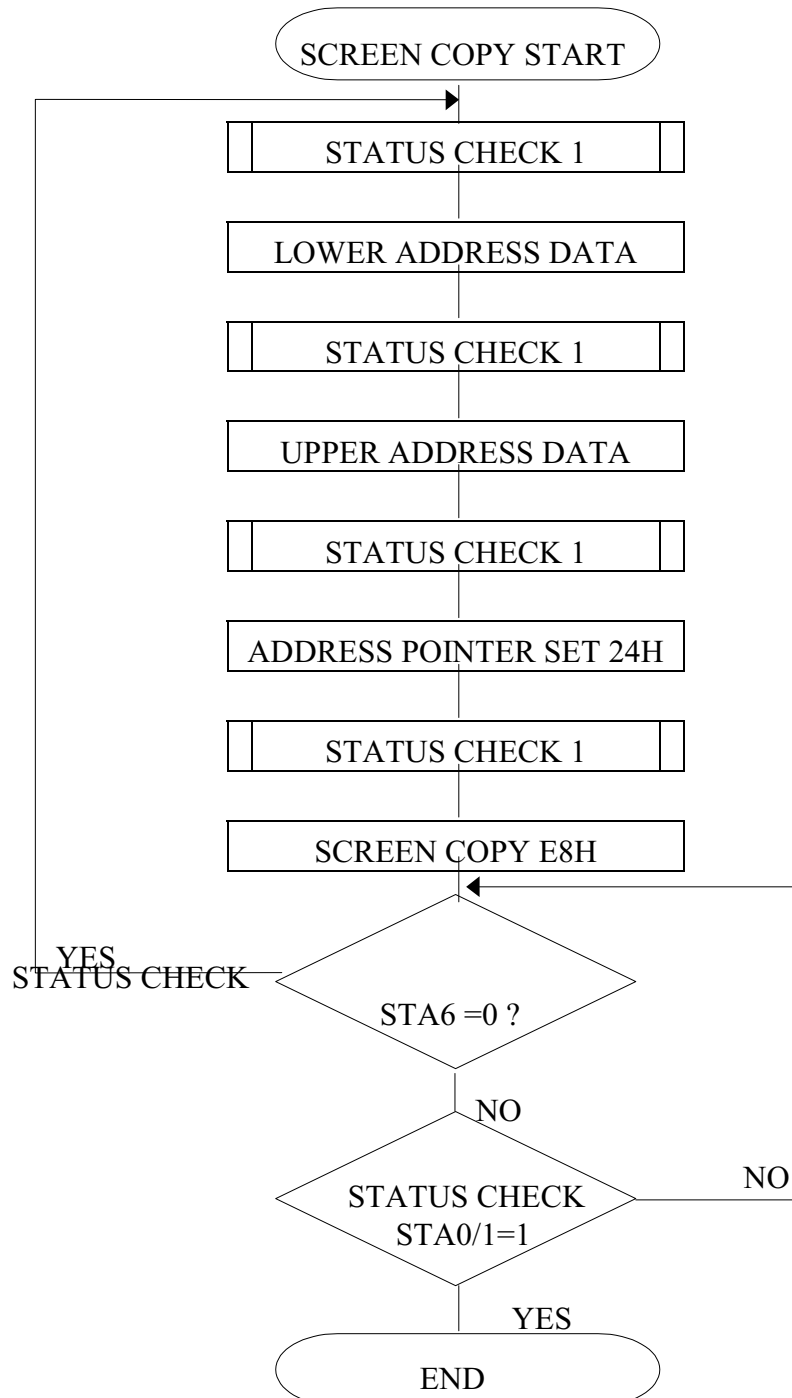

POWERTIP TECHNOLOGY CORPORATION

DISPLAY DEVICES FOR BETTER ELECTRONIC DESIGN

10.Bit set/reset

Code	Function	Operand
11110xxx	bit reset	-
11111xxx	bit set	-
1111x000	bit 9 (LSB)	-
1111x001	bit 1	-
1111x010	bit 2	-
1111x011	bit 3	-
1111x100	bit 4	-
1111x101	bit 5	-
1111x110	bit 6	-
1111x111	bit 7 (MSB)	-

This command is used to set or reset a bit of 1 byte is specified by address pointer. Plural bits in the byte data cannot be set/reset at a time.

1

Please refer following flow chart.

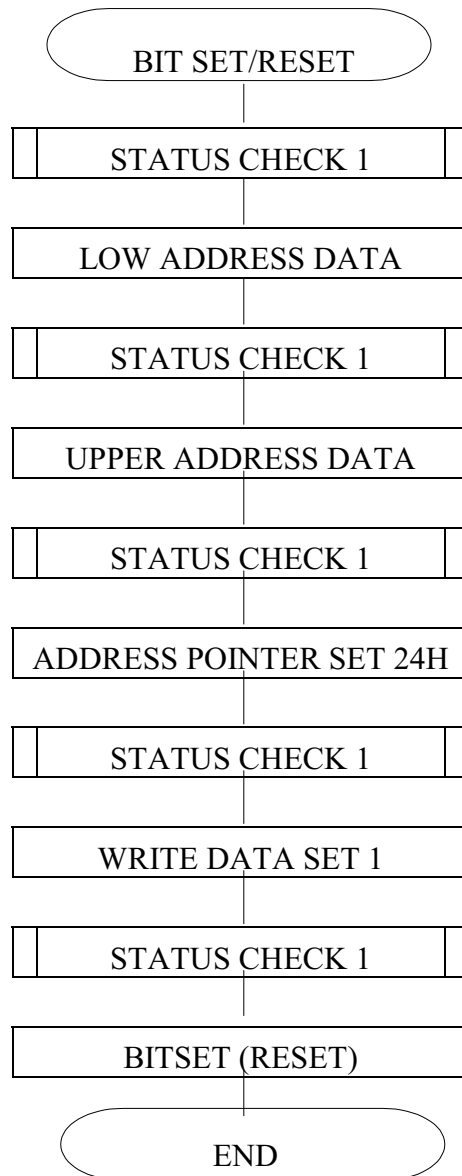

POWERTIP TECHNOLOGY CORPORATION

DISPLAY DEVICES FOR BETTER ELECTRONIC DESIGN

•Command list

Command	Code	D1	D2	Function
Register Set	00100001	X address	Y address	Cursor pointer set
	00100010	Data	00H	Offset register set
	00100100	Low address	High address	Address pointer set
Control Word Set	01000000	Low address	High address	Text home address set
	01000001	Columns	00H	Text area set
	01000010	Low address	High address	Graphic home address set
	01000011	Columns	00H	Graphic area set
Mode Set	1000x000	-	-	“OR” mode
	1000x001	-	-	“EXOR” mode
	1000x011	-	-	“AND” mode
	1000x100	-	-	“Text attribute” mode
	10000xxx	-	-	“Internal CG ROM mode
	10001xxx	-	-	“External CG CG RAM mode
Display Mode	10010000	-	-	Display off
	1001xx10	-	-	Cursor on, blink off
	1001xx11	-	-	Cursor on, blink on
	100101xx	-	-	Text on, graphic off
	100110xx	-	-	Text off, graphic on
	100111xx	-	-	Text on, graphic on
Cursor Pattern Select	10100000	-	-	1 line cursor
	10100001	-	-	2 lines cursor
	10100010	-	-	3 lines cursor
	10100011	-	-	4 lines cursor
	10100100	-	-	5 lines cursor
	10100101	-	-	6 lines cursor
	10100110	-	-	7 lines cursor
	10100111	-	-	8 lines cursor
Data Auto Read/Write	10110000	-	-	Data auto write set
	10110001	-	-	Data auto read set
	10110010	-	-	Auto reset
Data Read Write	11000000	Data	-	Data write and ADP increment
	11000001	-	-	Data read and ADP increment
	11000010	Data	-	Data write and ADP decrement
	11000011	-	-	Data read and ADP decrement
	11000100	Data	-	Data write and ADP nonvariable
	11000101	-	-	Data read and ADP nonvariable
Screen Peek	11100000	-	-	Screen peek
Screen Copy	11101000			Screen copy
Bit Set/Reset	11110xxx	-	-	bit reset
	11111xxx	-	-	bit set
	1111x000	-	-	bit0 (LSB)
	1111x001	-	-	bit1
	1111x010	-	-	bit2
	1111x011	-	-	bit3
	1111x100	-	-	bit4
	1111x101	-	-	bit5
	1111x110	-	-	bit6
	1111x111	-	-	bit7 (MSB)



POWERTIP TECHNOLOGY CORPORATION

DISPLAY DEVICES FOR BETTER ELECTRONIC DESIGN

1 2.Character pattern

.CHARACTER CODE MAP

ROM code 0101

F								
E								
D								
C								
B								
A								
9								
8								
7								
6								
5								
4								
3								
2								
1								
0								
LSB / MSB	0	1	2	3	4	5	6	7

POWERTIP TECHNOLOGY CORPORATION

MODEL NO.	PG12864LRU-FTA-H	VER.	0	PAGE	25 / 25
-----------	------------------	------	---	------	---------

128 x 64 dots 1/64 duty

OUTLINE DIMENSION & BLOCK DIAGRAM

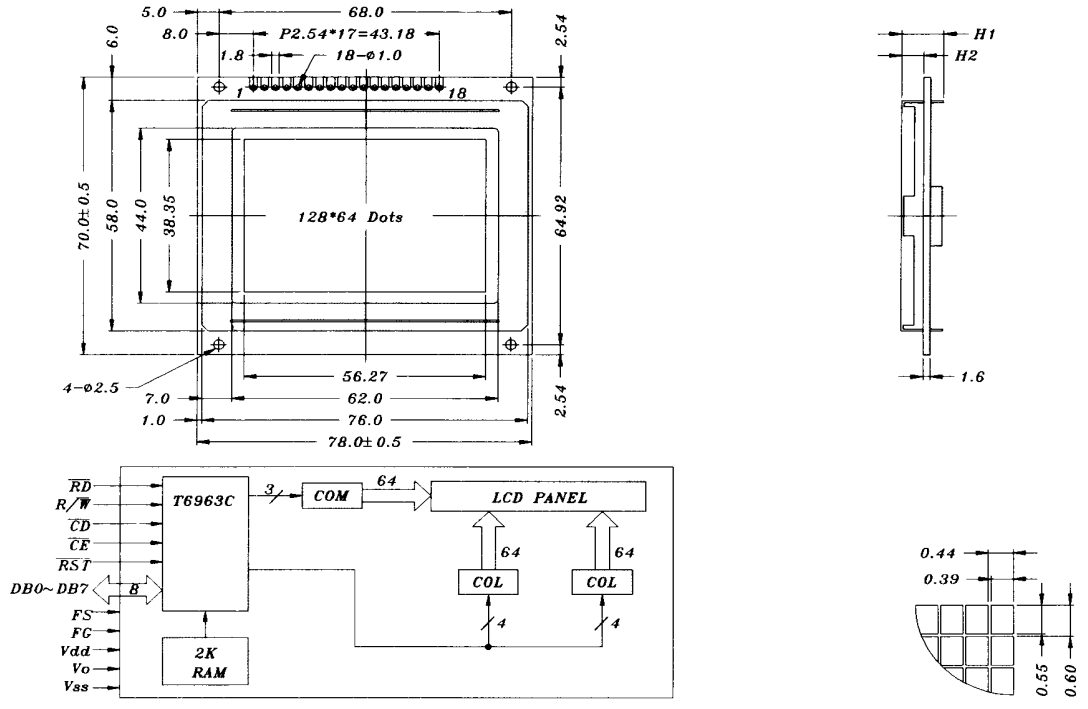

Unless classified; The tolerance ± 0.3mm

FEATURE

MECHANICAL SPECIFICATION

Number of dots	128 x 64	Overall size	78.0 x 70.0	Module	H2 / H1
Duty	1/64	View area	62.0 x 44.0	W/O B/L	5.1 / 9.7±0.5
BIAS	1/9	Dot size	0.39 x 0.55	EL B/L	5.1 / 9.7±0.5
Type	Positive/Negative	Dot pitch	0.44 x 0.60	LED B/L	- / -

PIN ASSIGNMENT

ABSOLUTE MAXIMUM RATING

Pin no.	Symbol	Function	Item	Symbol	Condition	Min.		Typ.		Max.		Unit		
						N	W	N	W	N	W			
1	FG	Frame ground	Supply for LCD driver Note: N:Nor. Temp. W:Wide Temp.	Vdd-Vo	Ta=-20°C	-	9.4	-	9.9	-	10.4	v		
2	Vss	Power supply (GND)			Ta=0°C	-	-	-	-	-	-	v		
3	Vdd	Power supply (+5V)			Ta=25°C	-	9.4	-	9.9	-	10.4	v		
4	Vo	Power supply for LCD driver			Ta=50°C	-	-	-	-	-	-	v		
5	WR	Data write			Ta=70°C	-	8.7	-	9.2	-	9.7	v		
6	RD	Data read			Supply for logic	Vdd-Vss	Ta=25°C	4.5		5.0		5.5		v
7	CE	Chip enable			Operation Temp.	Top	-	N	0	25	50	°C		
8	CD	Command / data read /write	W	-20				25	70					
9	RST	Controller reset	Storage Temp.	Tstg	-	N	-20	25	60	°C				
10-17	DB0-DB7	Data bus line				W	-30	25	80					
18	FS	Font select												