

Mobile Communications

Chapter 2: Wireless Transmission

Frequencies

Signals, antennas, signal propagation, MIMO

Multiplexing, Cognitive Radio

Spread spectrum, modulation

Cellular systems

Frequencies for communication

VLF = Very Low Frequency

LF = Low Frequency

MF = Medium Frequency

HF = High Frequency

VHF = Very High Frequency

UHF = Ultra High Frequency

SHF = Super High Frequency

EHF = Extra High Frequency

UV = Ultraviolet Light

Frequency and wave length

- $\lambda = c/f$

- wave length λ , speed of light $c \cong 3 \times 10^8 \text{m/s}$, frequency f

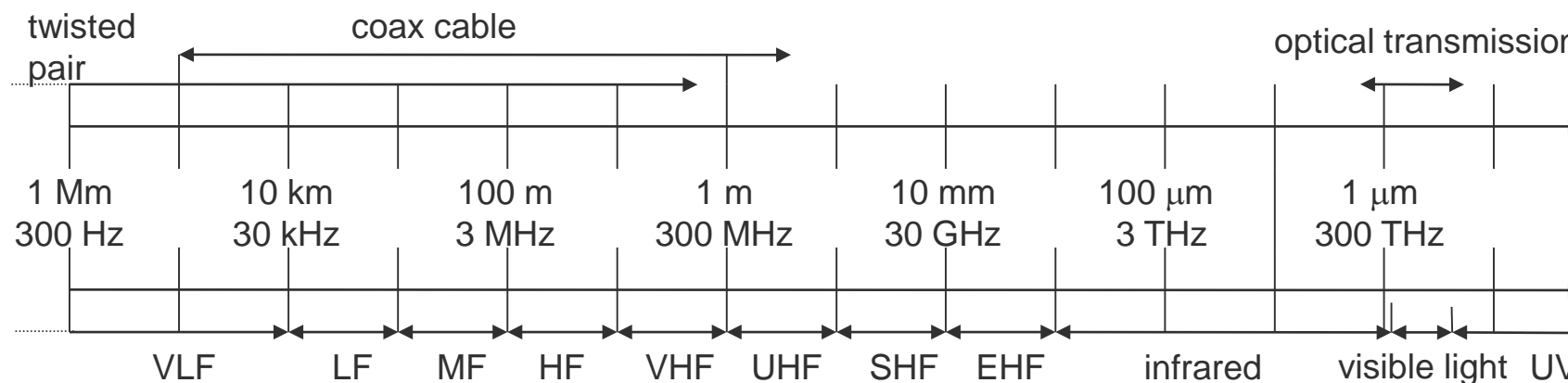

Example frequencies for mobile communication

VHF-/UHF-ranges for mobile radio

- simple, small antenna for cars
- deterministic propagation characteristics, reliable connections

SHF and higher for directed radio links, satellite communication

- small antenna, beam forming
- large bandwidth available

Wireless LANs use frequencies in UHF to SHF range

- some systems planned up to EHF
- limitations due to absorption by, e.g., water (dielectric heating, see microwave oven)
 - weather dependent fading, signal loss caused by heavy rainfall etc.

Frequencies and regulations

Examples	Europe	USA	Japan
Cellular networks	GSM 880-915, 925-960, 1710-1785, 1805-1880 UMTS 1920-1980, 2110-2170 LTE 791-821, 832-862, 2500-2690	AMPS, TDMA, CDMA, GSM 824-849, 869-894 TDMA, CDMA, GSM, UMTS 1850-1910, 1930-1990	PDC, FOMA 810-888, 893-958 PDC 1429-1453, 1477-1501 FOMA 1920-1980, 2110-2170
Cordless phones	CT1+ 885-887, 930-932 CT2 864-868 DECT 1880-1900	PACS 1850-1910, 1930-1990 PACS-UB 1910-1930	PHS 1895-1918 JCT 245-380
Wireless LANs	802.11b/g 2412-2472	802.11b/g 2412-2462	802.11b 2412-2484 802.11g 2412-2472
Other RF systems	27, 128, 418, 433, 868	315, 915	426, 868

In general: ITU-R holds auctions for new frequencies, manages frequency bands worldwide (WRC, World Radio Conferences); 3GPP specific: see e.g. [3GPP TS 36.101 V11.4.0 \(2013-03\)](#)

Signals I

Physical representation of data

Function of time and location

Signal parameters: parameters representing the value of data

Classification

- continuous time/discrete time
- continuous values/discrete values
- analog signal = continuous time and continuous values
- digital signal = discrete time and discrete values

Signal parameters of periodic signals:

- period T , frequency $f=1/T$, amplitude A , phase shift φ
- sine wave as special periodic signal for a carrier:

$$s(t) = A_t \sin(2 \pi f_t t + \varphi_t)$$

Fourier representation of periodic signals

$$g(t) = \frac{1}{2}c + \sum_{n=1}^{\infty} a_n \sin(2\pi nft) + \sum_{n=1}^{\infty} b_n \cos(2\pi nft)$$

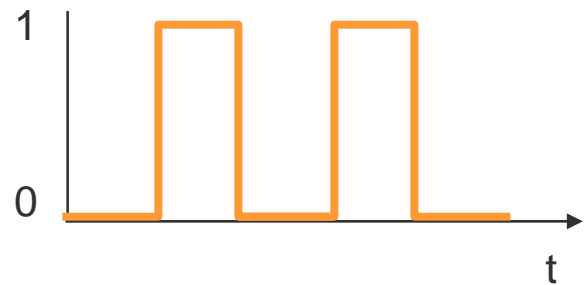

ideal periodic signal

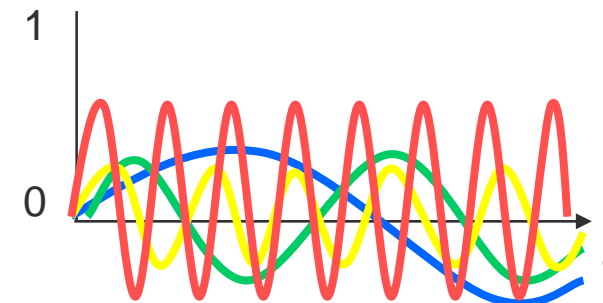

real composition
(based on harmonics)

Signals II

Different representations of signals

- amplitude (amplitude domain)
- frequency spectrum (frequency domain)
- constellation diagram (amplitude M and phase φ in polar coordinates)

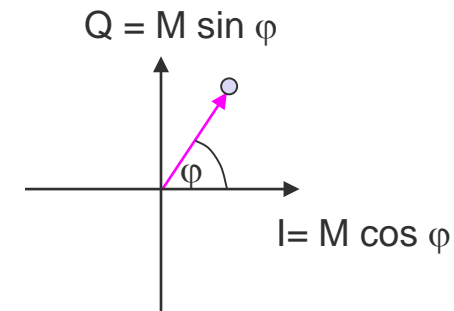
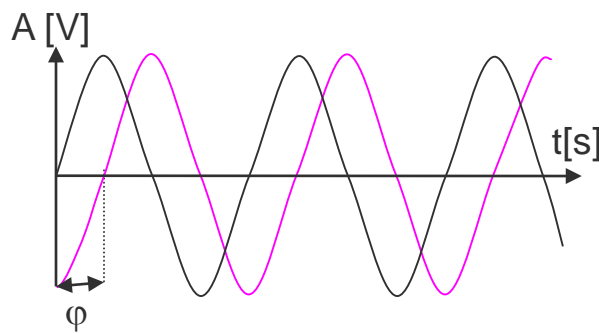

Composed signals transferred into frequency domain using Fourier transformation

Digital signals need

- infinite frequencies for perfect transmission
- modulation with a carrier frequency for transmission (analog signal!)

Antennas: isotropic radiator

Radiation and reception of electromagnetic waves, coupling of wires to space for radio transmission

Isotropic radiator: equal radiation in all directions (three dimensional) - only a theoretical reference antenna

Real antennas always have directive effects (vertically and/or horizontally)

Radiation pattern: measurement of radiation around an antenna

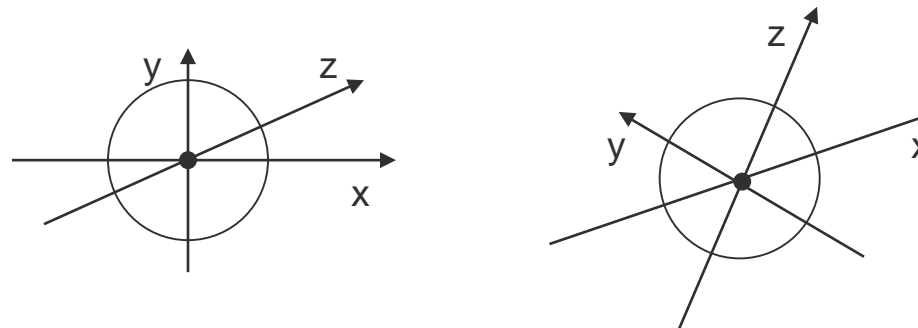

ideal
isotropic
radiator

Antennas: simple dipoles

Real antennas are not isotropic radiators but, e.g., dipoles with lengths $\lambda/4$ on car roofs or $\lambda/2$ as Hertzian dipole
 → shape of antenna proportional to wavelength



Example: Radiation pattern of a simple Hertzian dipole

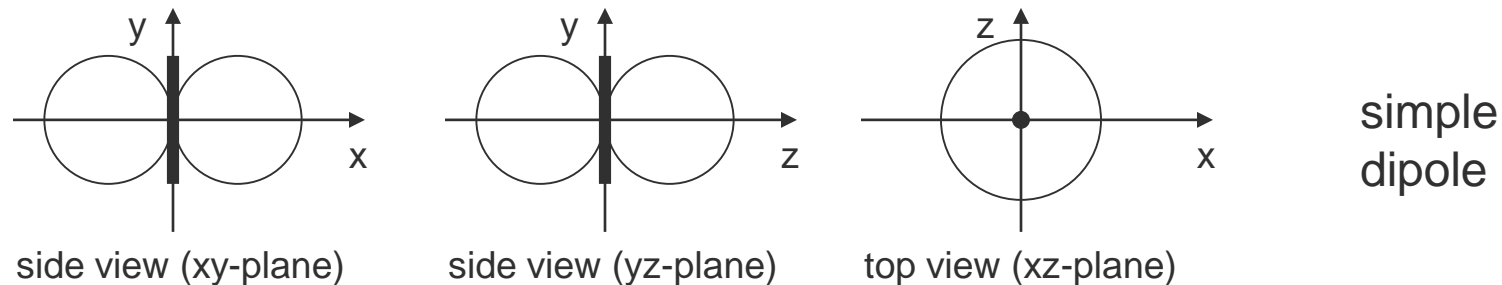

Gain: maximum power in the direction of the main lobe compared to the power of an isotropic radiator (with the same average power)

Antennas: directed and sectorized

Often used for microwave connections or base stations for mobile phones (e.g., radio coverage of a valley)

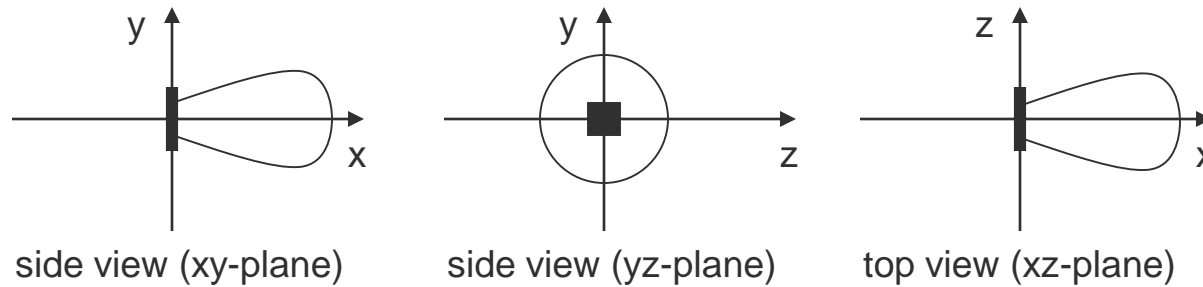

directed
antenna

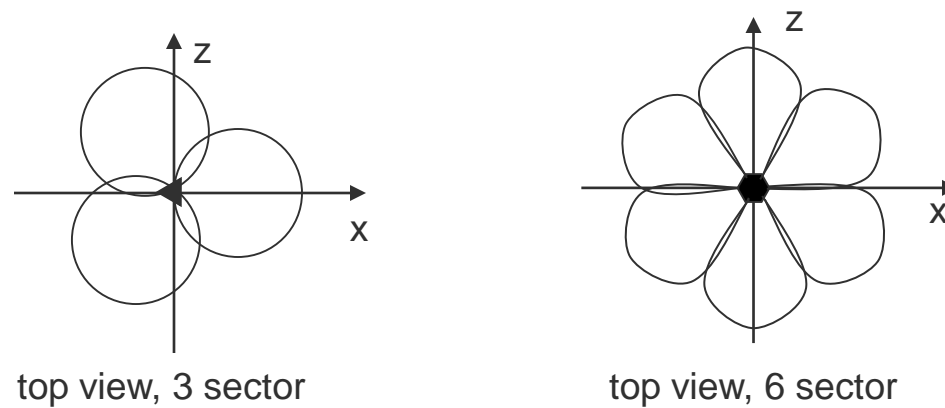

sectorized
antenna

Antennas: diversity

Grouping of 2 or more antennas

- multi-element antenna arrays

Antenna diversity

- switched diversity, selection diversity
 - receiver chooses antenna with largest output
- diversity combining
 - combine output power to produce gain
 - cophasing needed to avoid cancellation

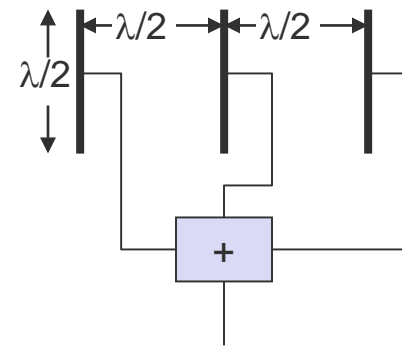
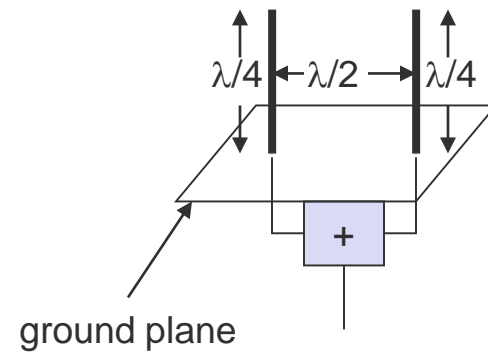

MIMO

Multiple-Input Multiple-Output

- Use of several antennas at receiver and transmitter
- Increased data rates and transmission range without additional transmit power or bandwidth via higher spectral efficiency, higher link robustness, reduced fading

Examples

- IEEE 802.11n, LTE, HSPA+, ...

Functions

- “Beamforming”: emit the same signal from all antennas to maximize signal power at receiver antenna
- Spatial multiplexing: split high-rate signal into multiple lower rate streams and transmit over different antennas
- Diversity coding: transmit single stream over different antennas with (near) orthogonal codes

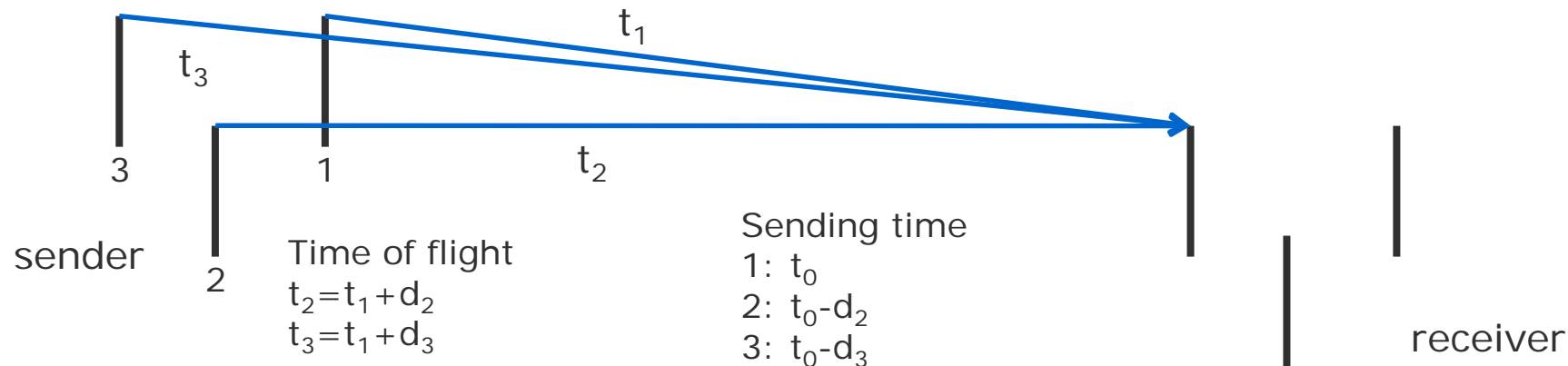

Signal propagation ranges

Transmission range

- communication possible
- low error rate

Detection range

- detection of the signal possible
- no communication possible

Interference range

- signal may not be detected
- signal adds to the background noise

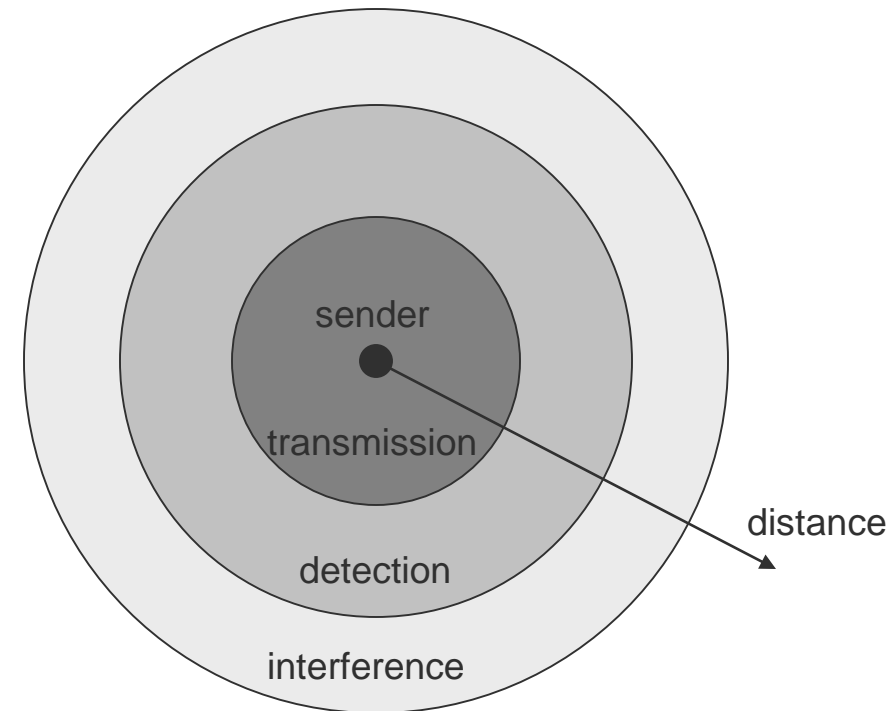

Warning: figure misleading – bizarre shaped, time-varying ranges in reality!

Signal propagation

Propagation in free space always like light (straight line)

Receiving power proportional to $1/d^2$ in vacuum – much more attenuation in real environments, e.g., $d^{3.5} \dots d^4$
 (d = distance between sender and receiver)

Receiving power additionally influenced by

- fading (frequency dependent)
- shadowing
- reflection at large obstacles
- refraction depending on the density of a medium
- scattering at small obstacles
- diffraction at edges

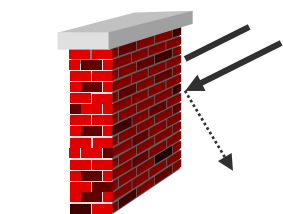

shadowing

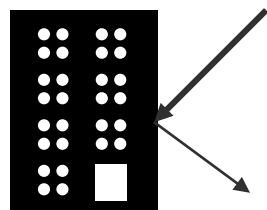

reflection

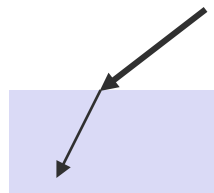

refraction



scattering

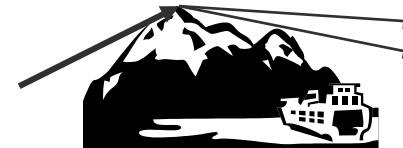

diffraction

Real world examples

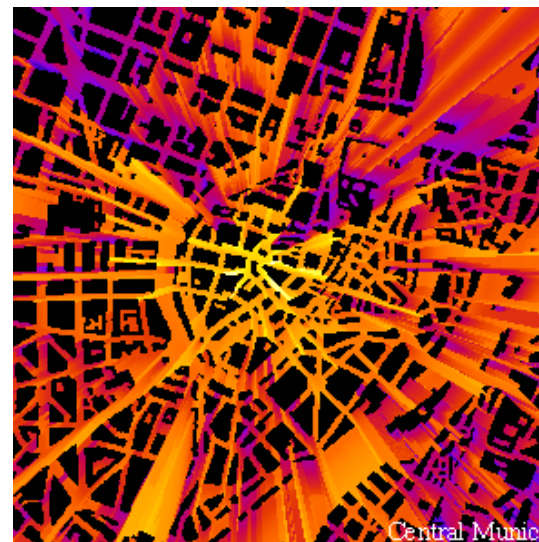
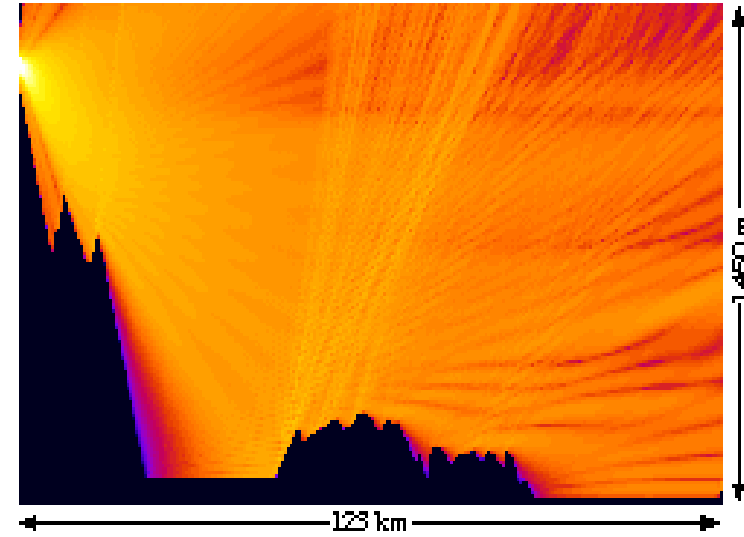
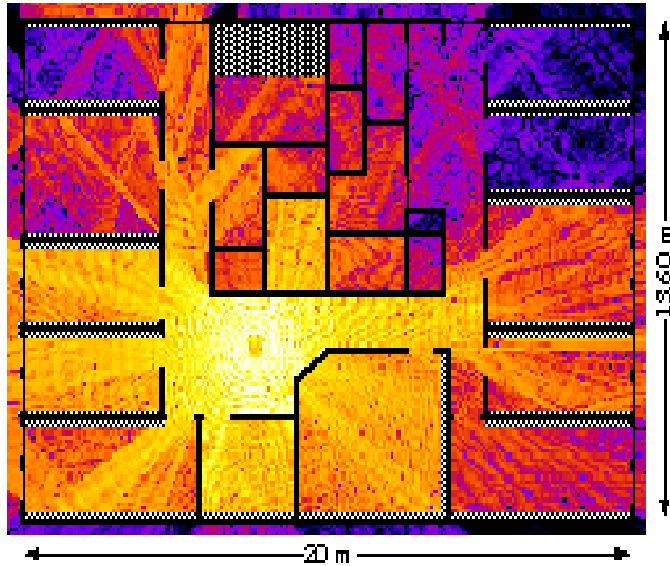

www.ihe.kit.edu/index.php

Multipath propagation

Signal can take many different paths between sender and receiver due to reflection, scattering, diffraction

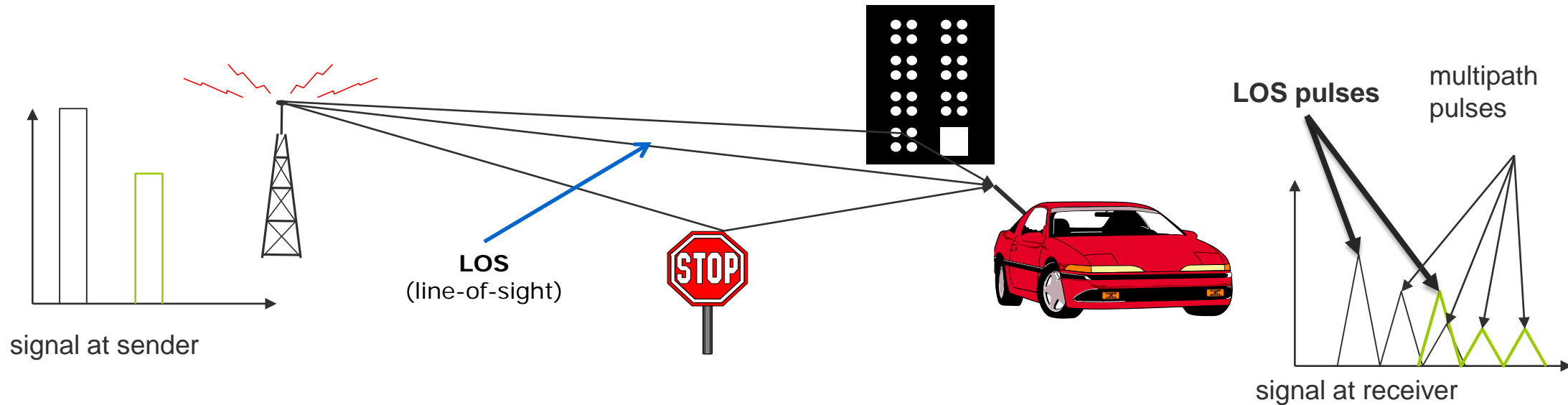

Time dispersion: signal is dispersed over time

- interference with "neighbor" symbols, Inter Symbol Interference (ISI)

The signal reaches a receiver directly and phase shifted

- distorted signal depending on the phases of the different parts

Effects of mobility

Channel characteristics change over time and location

- signal paths change
- different delay variations of different signal parts
- different phases of signal parts

➔ quick changes in the power received (short term fading)

Additional changes in

- distance to sender
- obstacles further away

➔ slow changes in the average power received (long term fading)

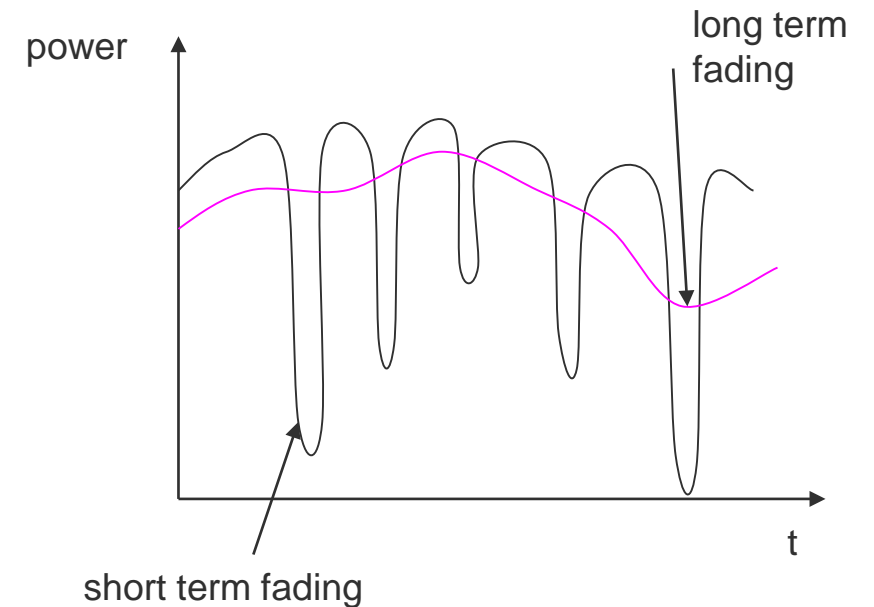

Multiplexing

Multiplexing in 4 dimensions

- space (s_i)
- time (t)
- frequency (f)
- code (c)

Goal: multiple use of a shared medium

Important: guard spaces needed!

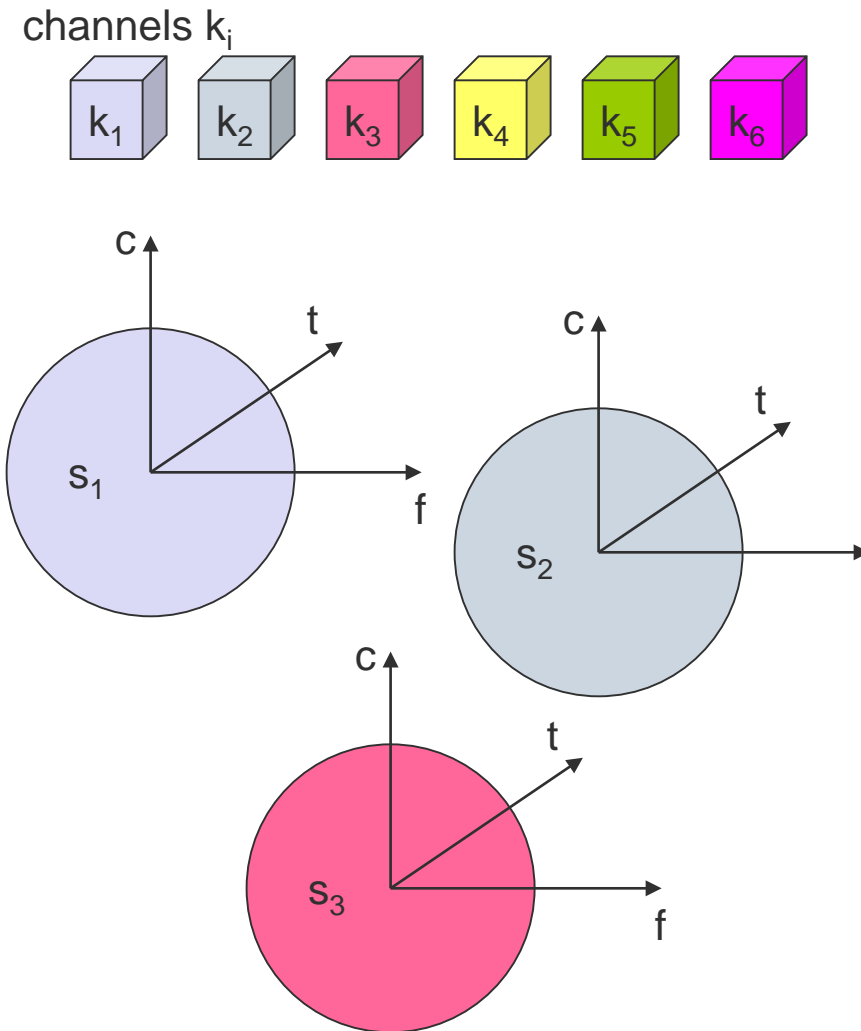

Frequency multiplex

Separation of the whole spectrum into smaller frequency bands
 A channel gets a certain band of the spectrum for the whole time

Advantages

- no dynamic coordination necessary
- works also for analog signals

Disadvantages

- waste of bandwidth if the traffic is distributed unevenly
- inflexible

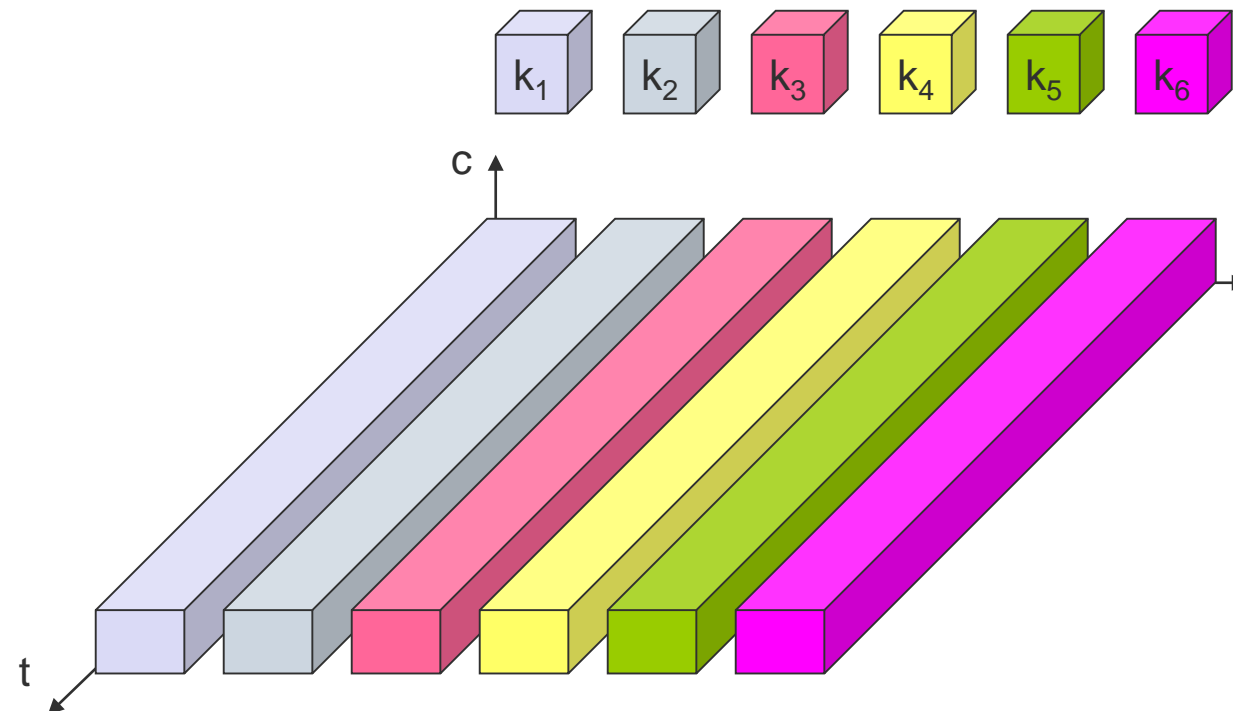

Time multiplex

A channel gets the whole spectrum for a certain amount of time

Advantages

- only one carrier in the medium at any time
- throughput high even for many users

Disadvantages

- precise synchronization necessary

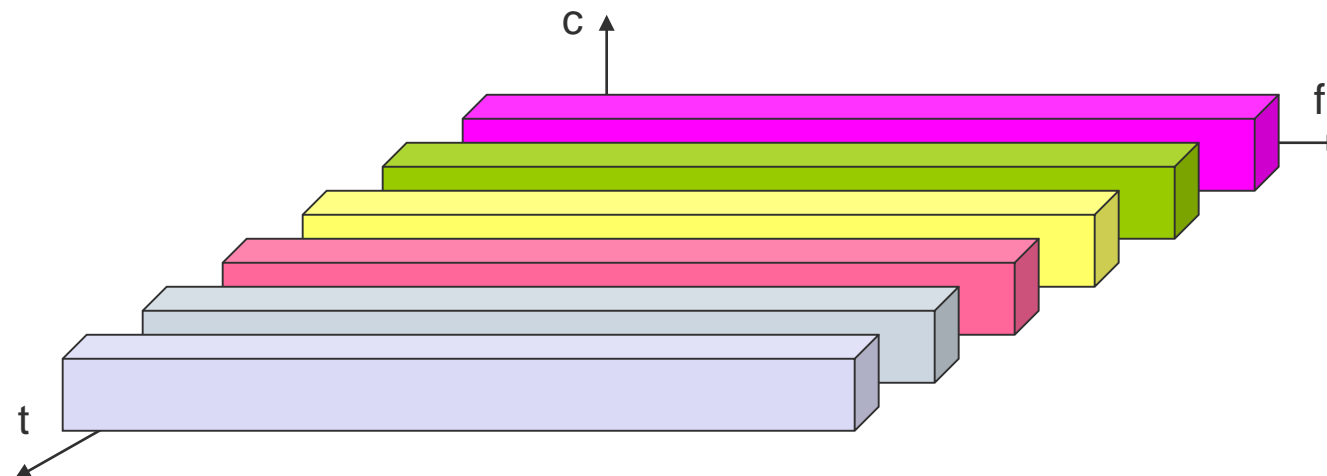
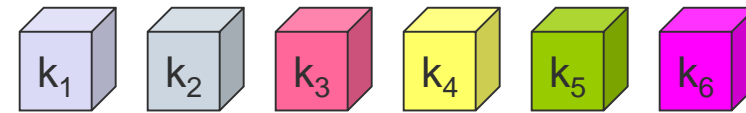

Time and frequency multiplex

Combination of both methods

A channel gets a certain frequency band for a certain amount of time

Example: GSM, Bluetooth

Advantages

- better protection against tapping
- protection against frequency selective interference

but: precise coordination required

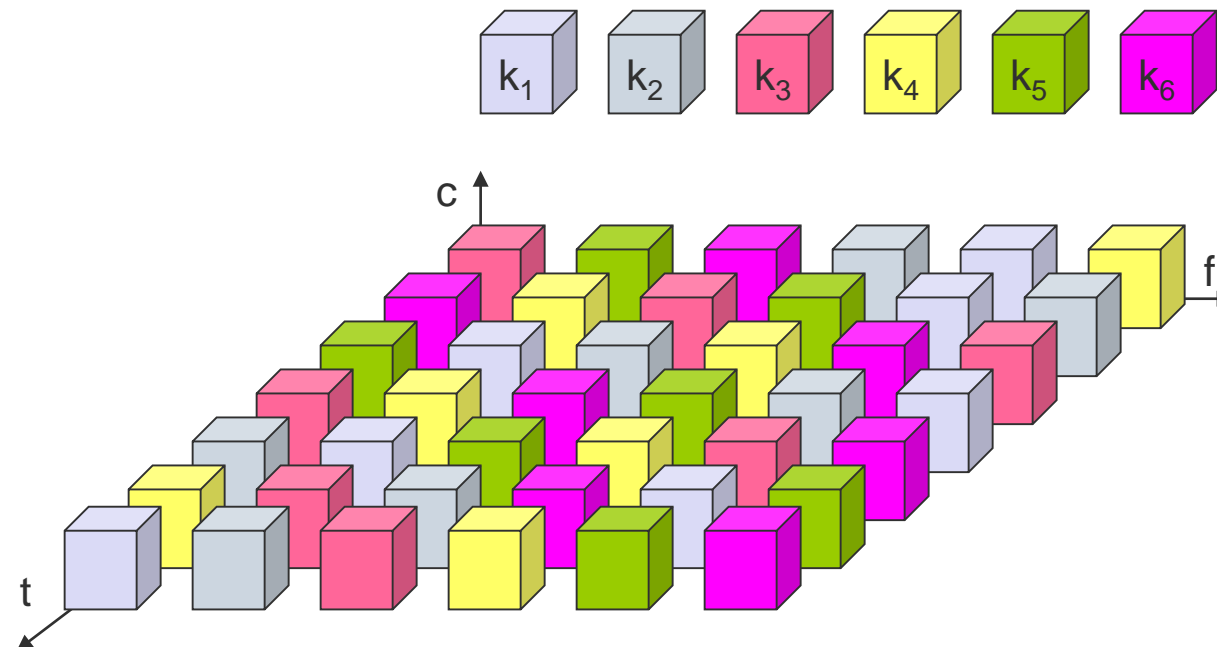

Cognitive Radio

Typically in the form of a spectrum sensing CR

- Detect unused spectrum and share with others avoiding interference
- Choose automatically best available spectrum (intelligent form of time/frequency/space multiplexing)

Distinguish

- Primary Users (PU): users assigned to a specific spectrum by e.g. regulation
- Secondary Users (SU): users with a CR to use unused spectrum

Examples

- Reuse of (regionally) unused analog TV spectrum (aka white space)
- Temporary reuse of unused spectrum e.g. of pagers, amateur radio etc.

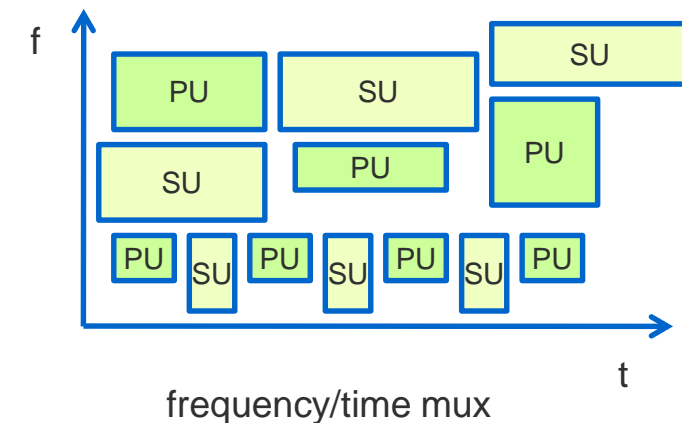
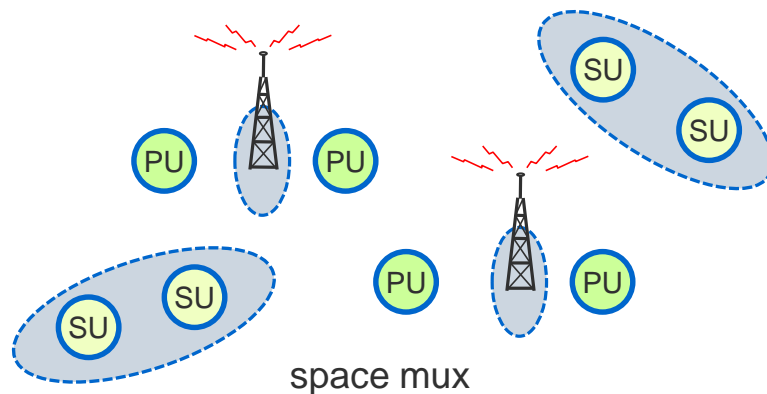

Code multiplex

Each channel has a unique code

All channels use the same spectrum at the same time

Advantages

- bandwidth efficient
- no coordination and synchronization necessary
- good protection against interference and tapping

Disadvantages

- varying user data rates
- more complex signal regeneration

Implemented using spread spectrum technology

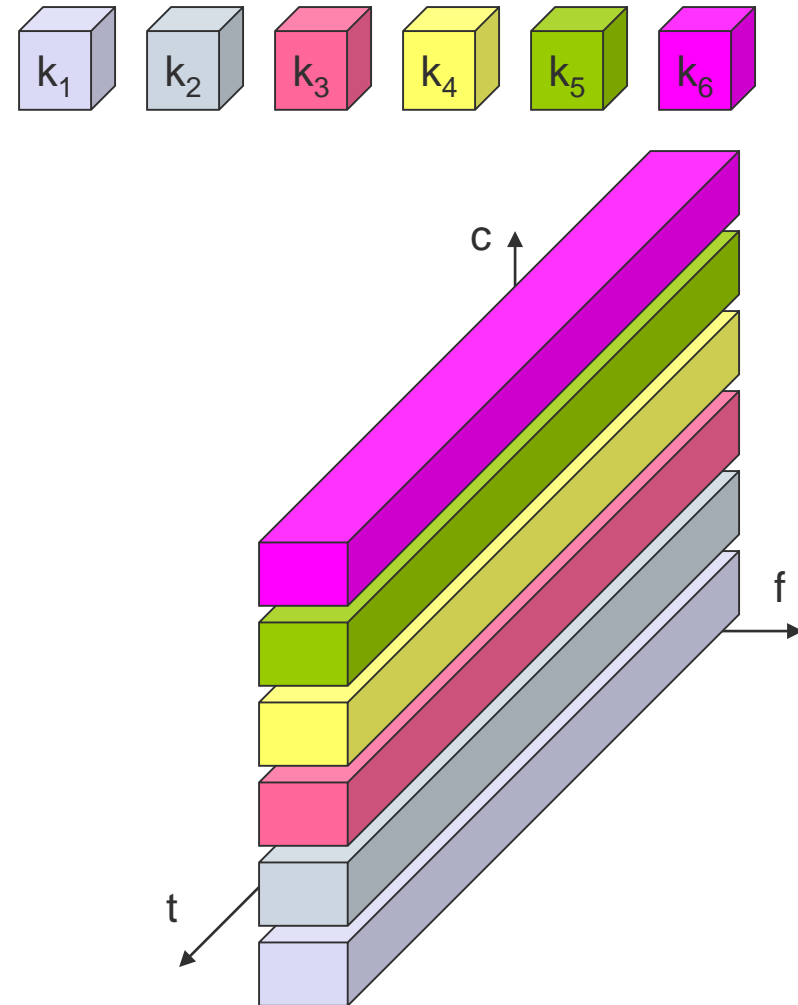

Modulation

Digital modulation

- digital data is translated into an analog signal (baseband)
- ASK, FSK, PSK - main focus in this chapter
- differences in spectral efficiency, power efficiency, robustness

Analog modulation

- shifts center frequency of baseband signal up to the radio carrier

- Motivation
 - smaller antennas (e.g., $\lambda/4$)
 - Frequency Division Multiplexing
 - medium characteristics

- Basic schemes
 - Amplitude Modulation (AM)
 - Frequency Modulation (FM)
 - Phase Modulation (PM)

Modulation and demodulation

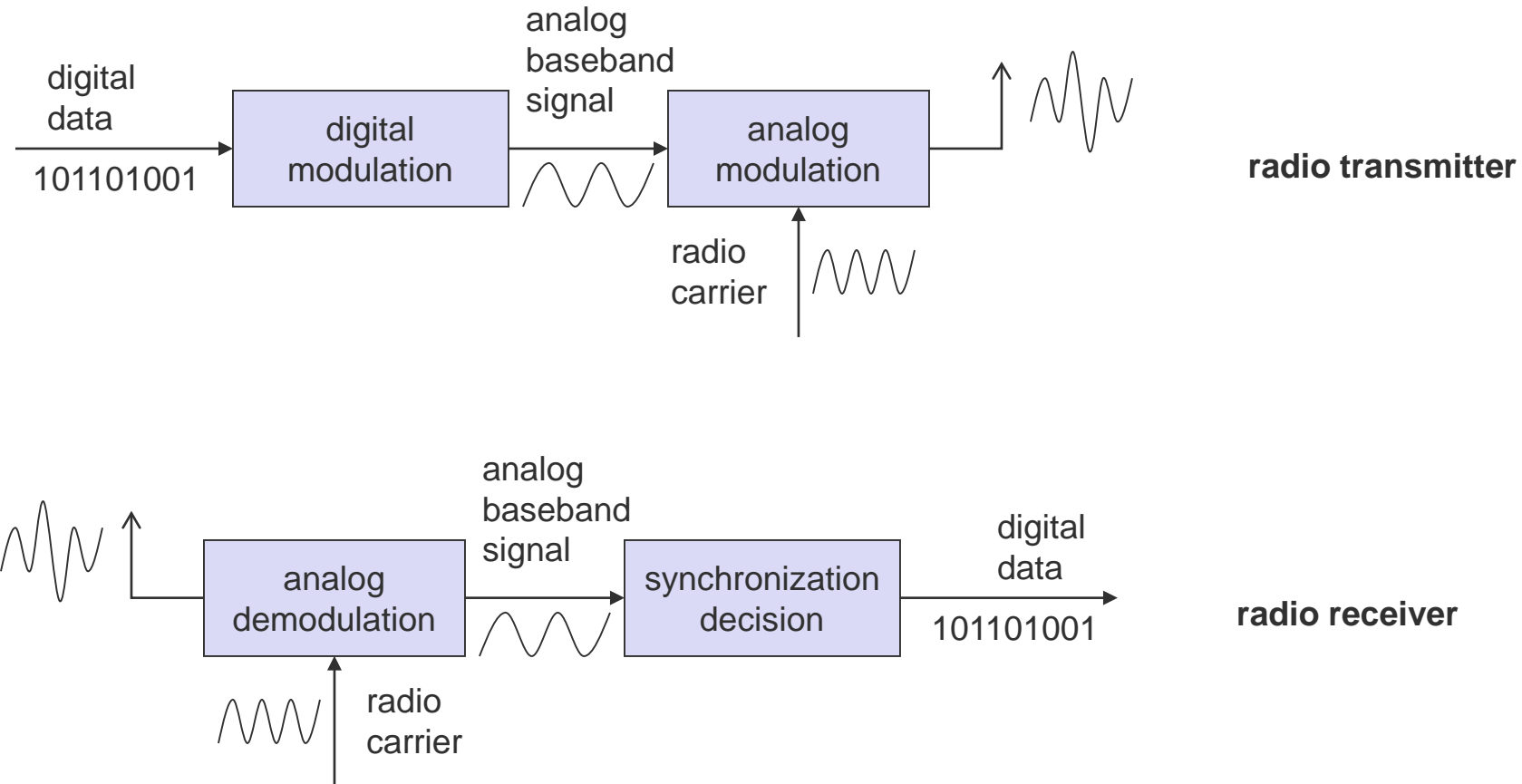

Digital modulation

Modulation of digital signals known as Shift Keying

Amplitude Shift Keying (ASK):

- very simple
- low bandwidth requirements
- very susceptible to interference

Frequency Shift Keying (FSK):

- needs larger bandwidth

Phase Shift Keying (PSK):

- more complex
- robust against interference

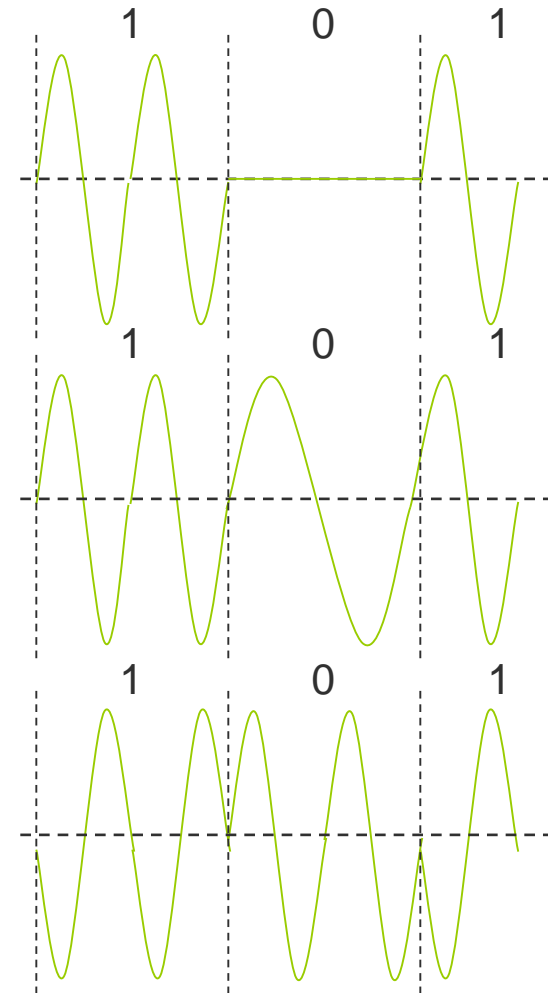

Advanced Frequency Shift Keying

Bandwidth needed for FSK depends on the distance between the carrier frequencies

Special pre-computation avoids sudden phase shifts → MSK (Minimum Shift Keying)

- bit separated into even and odd bits, the duration of each bit is doubled
- depending on the bit values (even, odd) the higher or lower frequency, original or inverted is chosen
- the frequency of one carrier is twice the frequency of the other
- Equivalent to offset QPSK

Even higher bandwidth efficiency using a Gaussian low-pass filter → GMSK (Gaussian MSK), used in GSM

Example of MSK

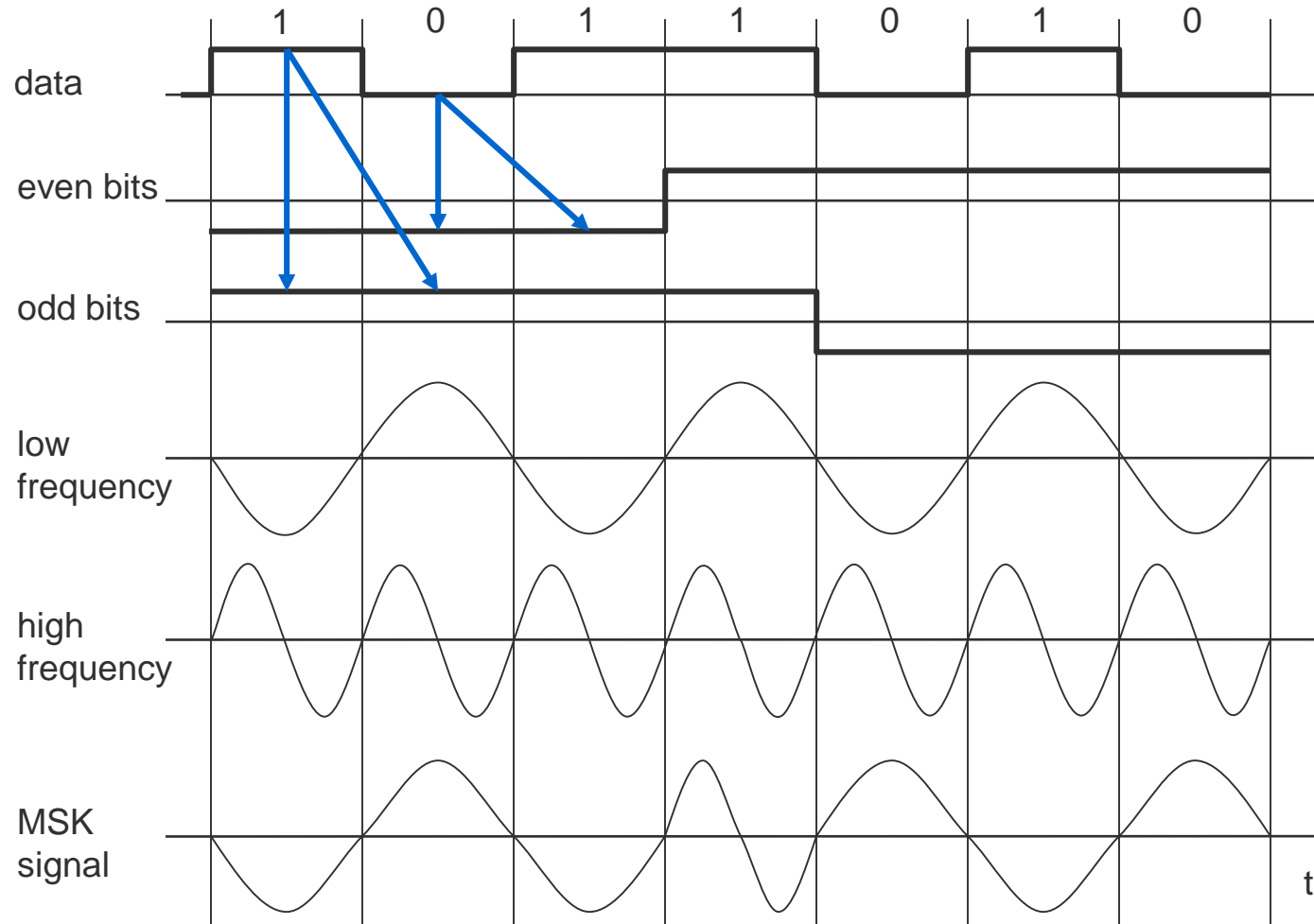

bit	
even	0 1 0 1
odd	0 0 1 1
signal value	h n n h - - + +

h: high frequency
n: low frequency
+: original signal
-: inverted signal

No phase shifts!

Advanced Phase Shift Keying

BPSK (Binary Phase Shift Keying):

- bit value 0: sine wave
- bit value 1: inverted sine wave
- very simple PSK
- low spectral efficiency
- robust, used e.g. in satellite systems

QPSK (Quadrature Phase Shift Keying):

- 2 bits coded as one symbol
- symbol determines shift of sine wave
- needs less bandwidth compared to BPSK
- more complex

Often also transmission of relative, not absolute phase shift

- DQPSK - Differential QPSK (IS-136, PHS)

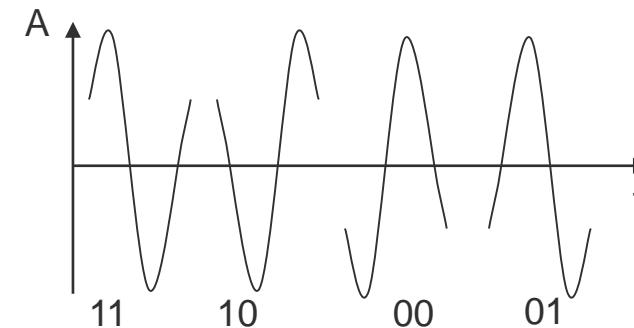
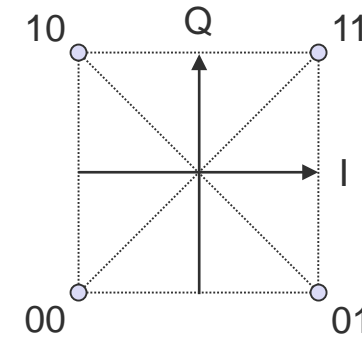
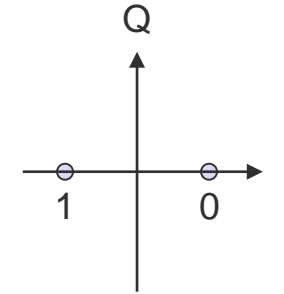

Quadrature Amplitude Modulation

Quadrature Amplitude Modulation (QAM)

- combines amplitude and phase modulation
- it is possible to code n bits using one symbol
- 2^n discrete levels, $n=2$ identical to QPSK

Bit error rate increases with n , but less errors compared to comparable PSK schemes

- Example: 16-QAM (4 bits = 1 symbol)
- Symbols 0011 and 0001 have the same phase φ , but different amplitude a . 0000 and 1000 have different phase, but same amplitude.

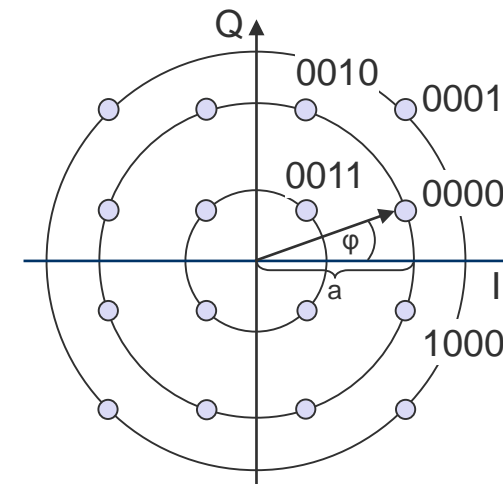

Hierarchical Modulation

DVB-T modulates two separate data streams onto a single DVB-T stream

High Priority (HP) embedded within a Low Priority (LP) stream

Multi carrier system, about 2000 or 8000 carriers

QPSK, 16 QAM, 64QAM (the newer DVB-T2 can additionally use 256QAM)

Example: 64QAM

- good reception: resolve the entire 64QAM constellation
- poor reception, mobile reception: resolve only QPSK portion
- 6 bit per QAM symbol, 2 most significant determine QPSK
- HP service coded in QPSK (2 bit), LP uses remaining 4 bit

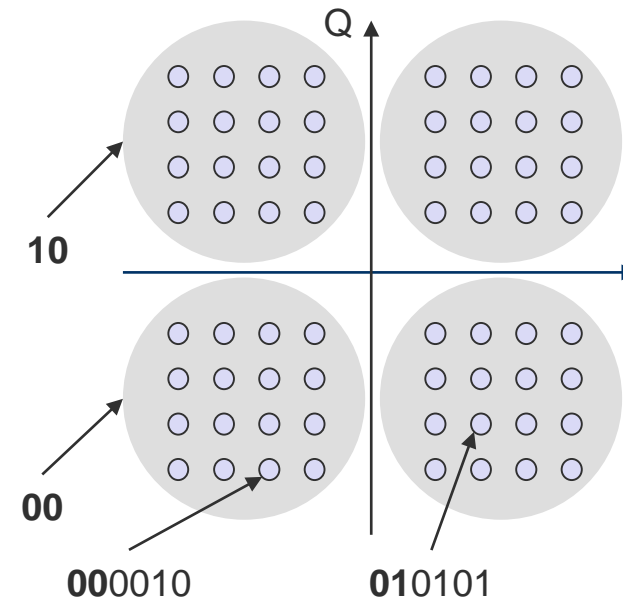

Spread spectrum technology

Problem of radio transmission: frequency dependent fading can wipe out narrow band signals for duration of the interference

Solution: spread the narrow band signal into a broad band signal using a special code

- protection against narrow band interference

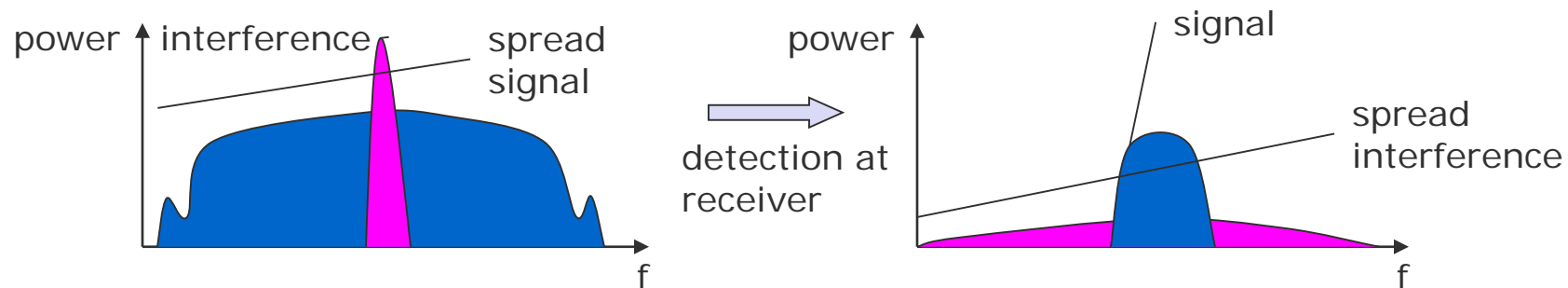

Side effects:

- coexistence of several signals without dynamic coordination
- tap-proof

Alternatives: Direct Sequence, Frequency Hopping

Effects of spreading and interference

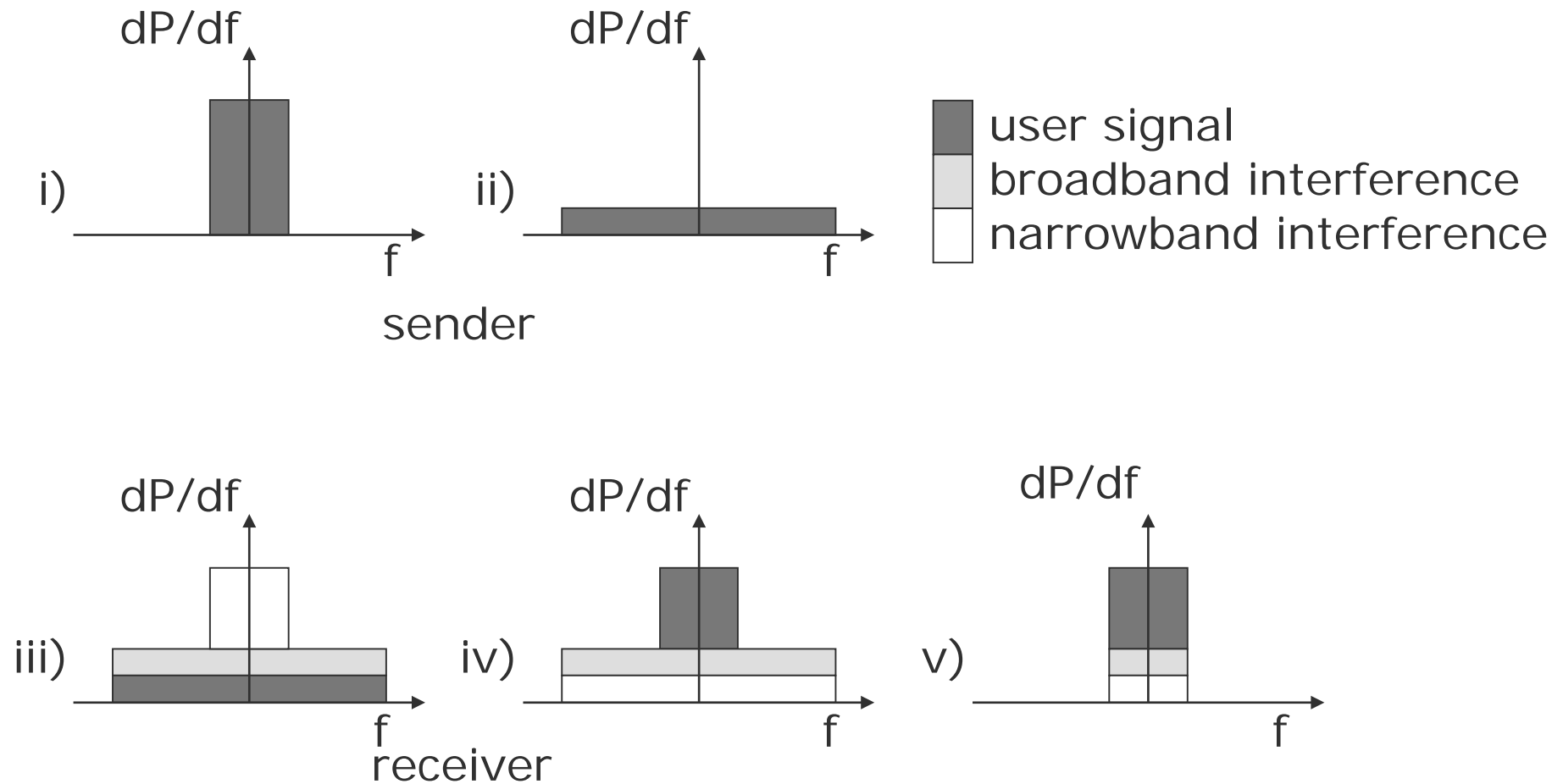

Spreading and frequency selective fading

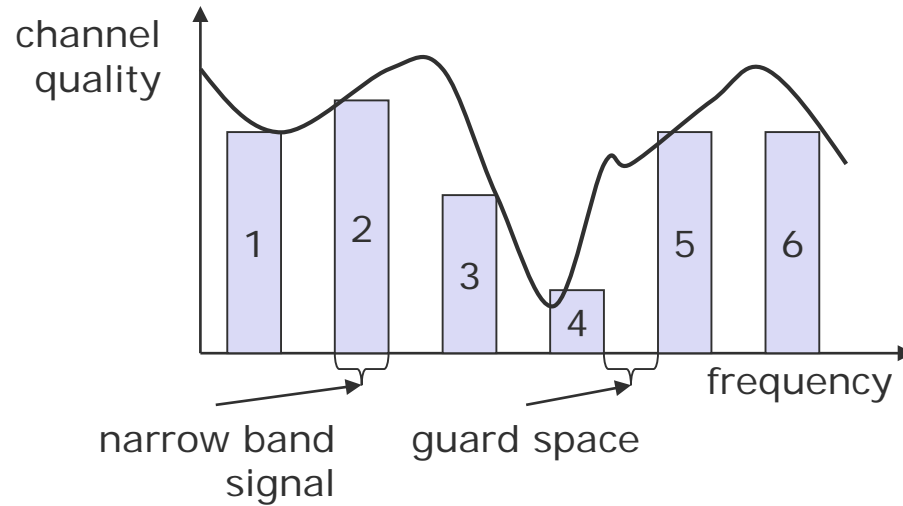

narrowband channels

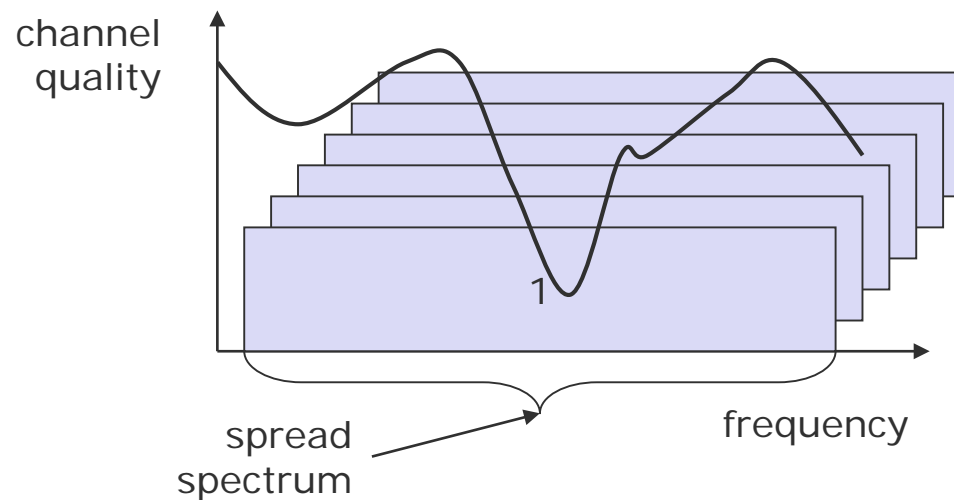

spread spectrum channels

DSSS (Direct Sequence Spread Spectrum) I

XOR of the signal with pseudo-random number (chipping sequence)

- many chips per bit (e.g., 128) result in higher bandwidth of the signal

Advantages

- reduces frequency selective fading
- in cellular networks
 - base stations can use the same frequency range
 - several base stations can detect and recover the signal
 - soft handover

Disadvantages

- precise power control necessary

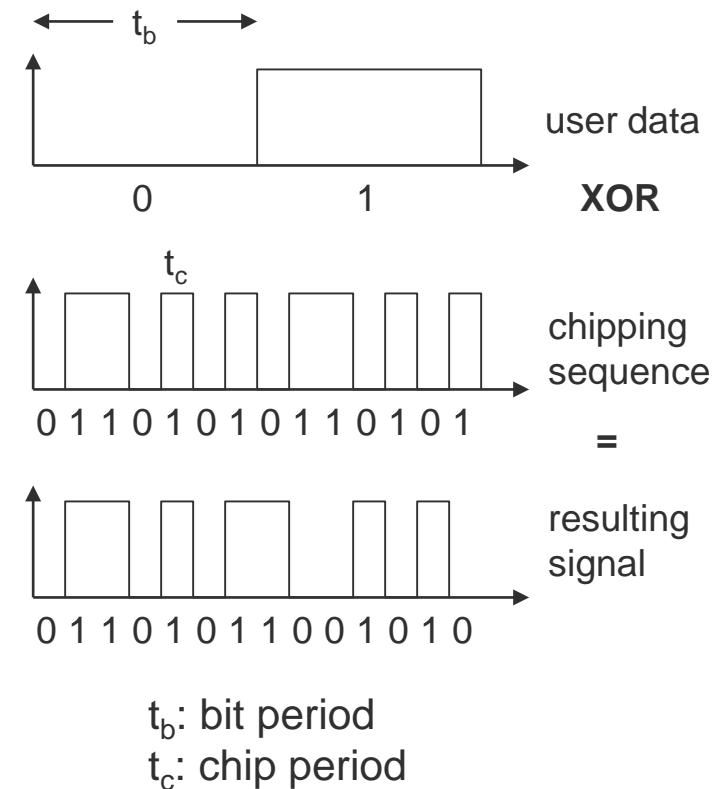

DSSS (Direct Sequence Spread Spectrum) II

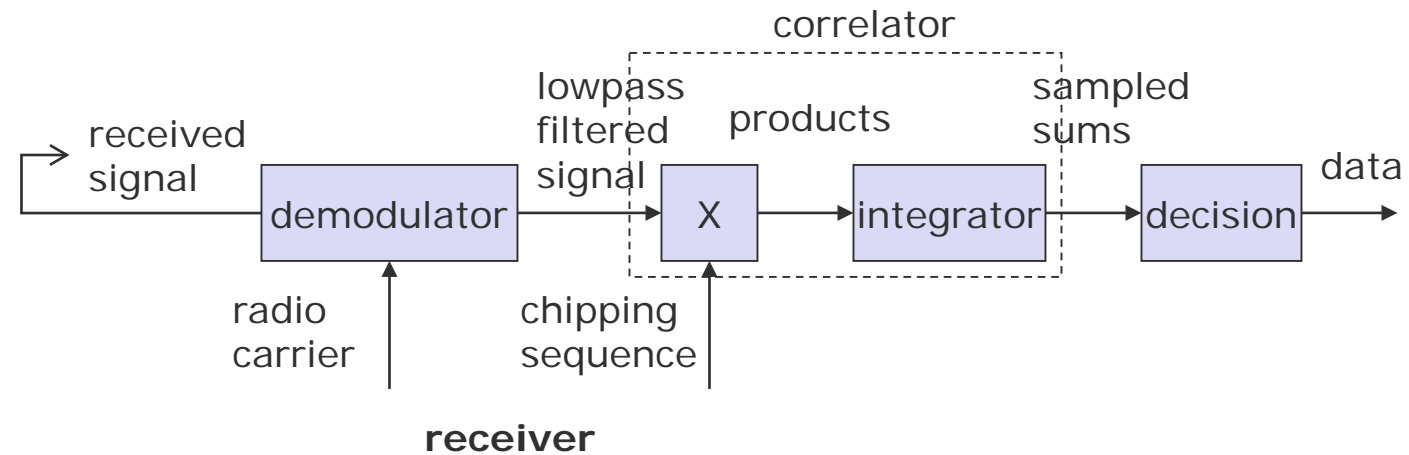
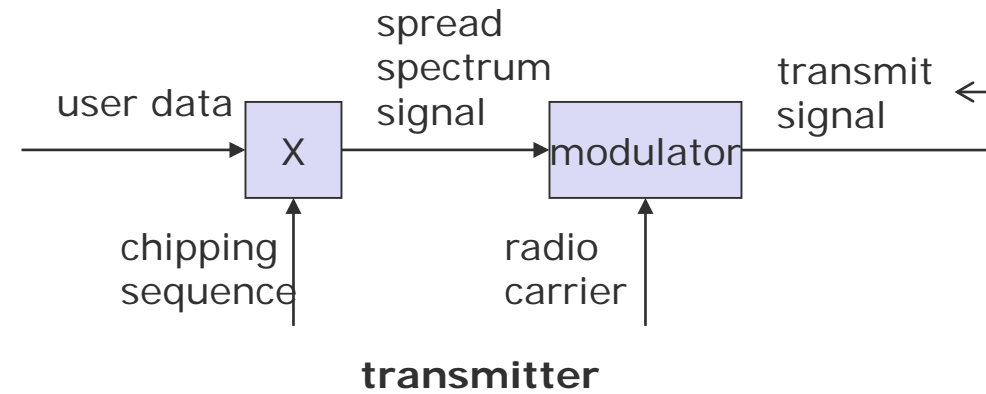

FHSS (Frequency Hopping Spread Spectrum) I

Discrete changes of carrier frequency

- sequence of frequency changes determined via pseudo random number sequence

Two versions

- Fast Hopping:
several frequencies per user bit
- Slow Hopping:
several user bits per frequency

Advantages

- frequency selective fading and interference limited to short period
- simple implementation
- uses only small portion of spectrum at any time

Disadvantages

- not as robust as DSSS
- simpler to detect

FHSS (Frequency Hopping Spread Spectrum) II

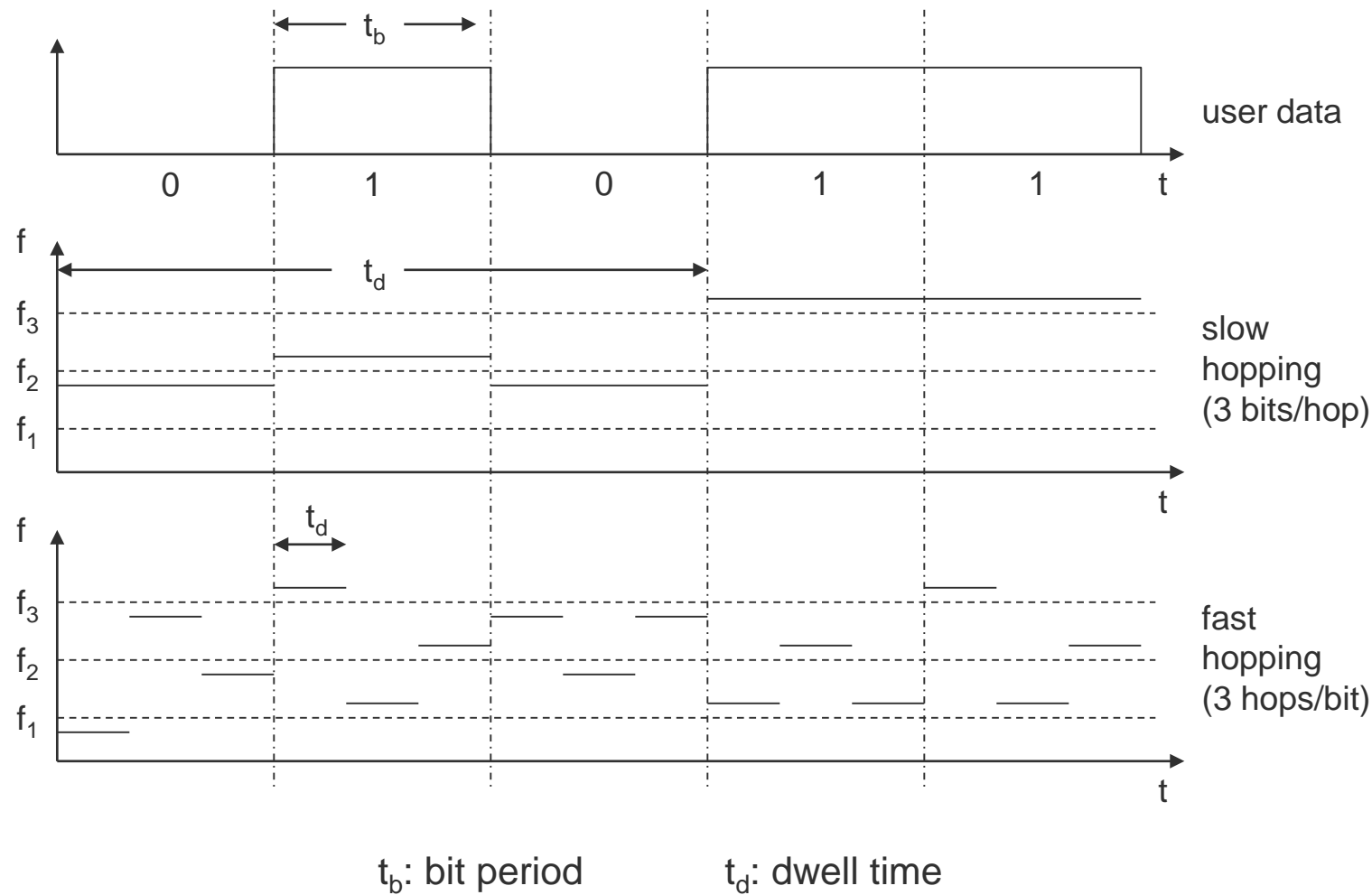

FHSS (Frequency Hopping Spread Spectrum) III

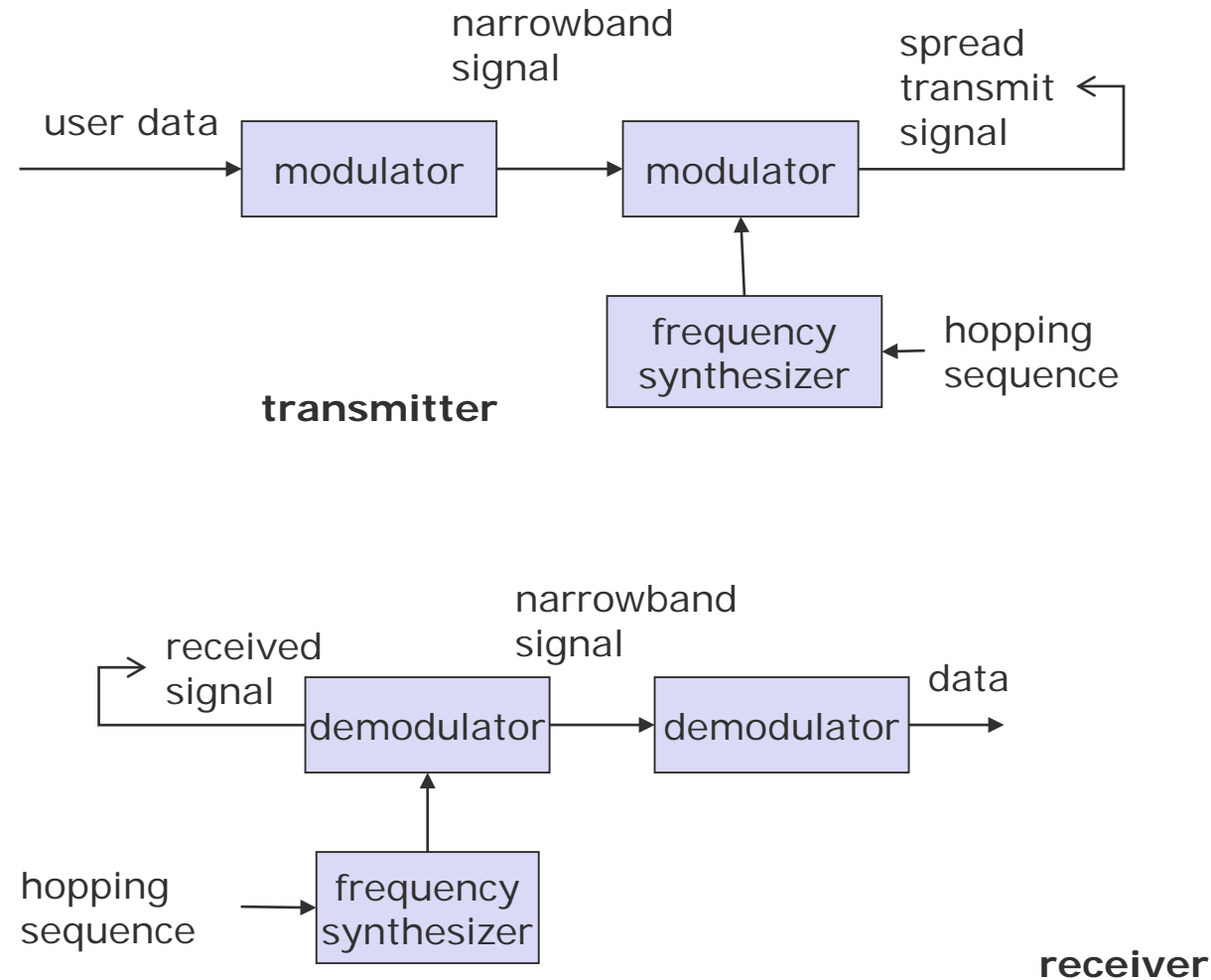

Software Defined Radio

Basic idea (ideal world)

- Full flexibility wrt modulation, carrier frequency, coding...
- Simply download a new radio!
- Transmitter: digital signal processor plus very fast D/A-converter
- Receiver: very fast A/D-converter plus digital signal processor

Real world

- Problems due to interference, high accuracy/high data rate, low-noise amplifiers needed, filters etc.

Examples

- Joint Tactical Radio System, GNU Radio, Universal Software Radio Peripheral, ...
- see e.g. SDR – 20 Years Later, IEEE Communications Magazine, Sept. 2015 and Jan. 2016

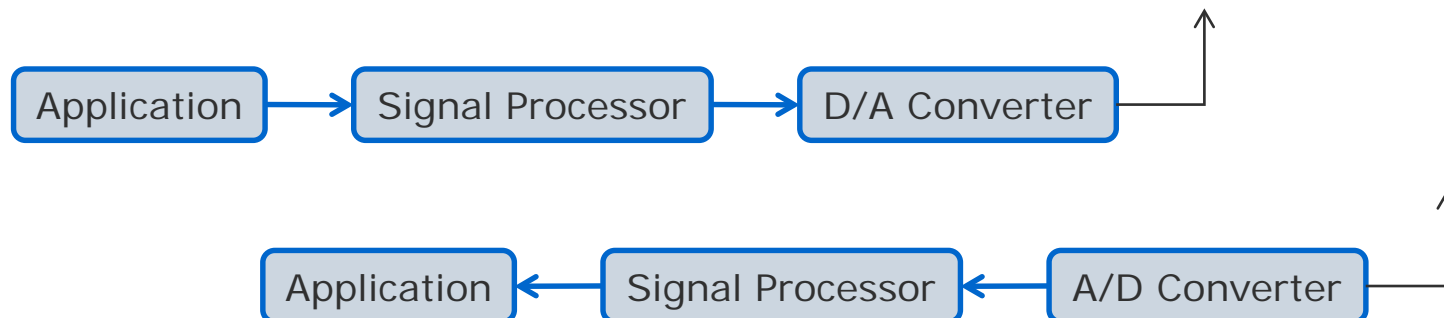

Cell structure

Implements space division multiplex

- base station covers a certain transmission area (cell)

Mobile stations communicate only via the base station

Advantages of cell structures

- higher capacity, higher number of users
- less transmission power needed
- more robust, decentralized
- base station deals with interference, transmission area etc. locally

Problems

- fixed network needed for the base stations
- handover (changing from one cell to another) necessary
- interference with other cells

Cell sizes from some 100 m in cities to, e.g., 35 km on the country side (GSM) - even less for higher frequencies

Frequency planning I

Frequency reuse only with a certain distance between the base stations

Standard model using 7 frequencies:

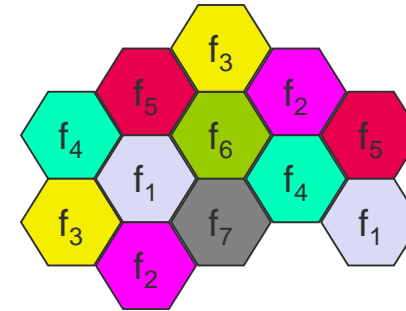

Fixed frequency assignment:

- certain frequencies are assigned to a certain cell
- problem: different traffic load in different cells

Dynamic frequency assignment:

- base station chooses frequencies depending on the frequencies already used in neighbor cells
- more capacity in cells with more traffic
- assignment can also be based on interference measurements

Frequency planning II

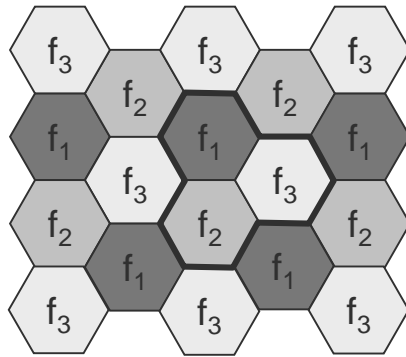

3 cell cluster

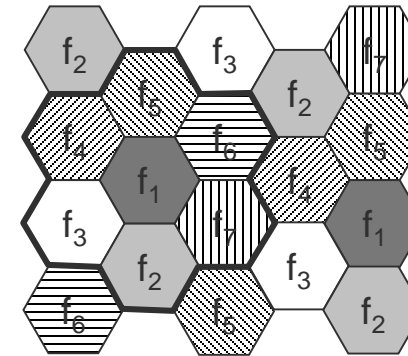

7 cell cluster

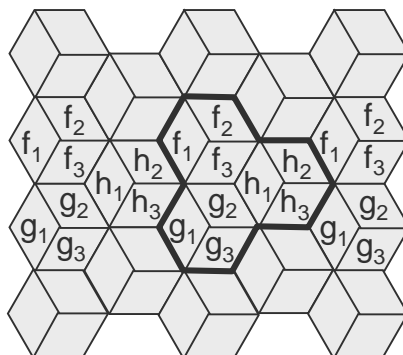

3 cell cluster
with 3 sector antennas

Cell breathing

CDM systems: cell size depends on current load
 Additional traffic appears as noise to other users
 If the noise level is too high users drop out of cells

